

# 805-8 Machine Monitor

## Installation and Operating Manual

Doc # L-805-1091  
Rev. 00



Link Electric & Safety Control Co.  
444 McNally Drive  
Nashville, TN 37211

Phone: (615) 833-4168  
Fax: (615) 834-1984

© 2016

# System 5100



# Table of Contents

|       |                                       |    |
|-------|---------------------------------------|----|
| 1     | INTRODUCTION .....                    | 4  |
| 1.1   | Features .....                        | 4  |
| 1.2   | Specifications .....                  | 4  |
| 2     | DEFINITIONS AND TERMINOLOGY .....     | 5  |
| 2.1   | Stops .....                           | 5  |
| 2.1.1 | Immediate Stop .....                  | 5  |
| 2.1.2 | Top Stop .....                        | 5  |
| 3     | OPERATION .....                       | 6  |
| 3.1   | Operator Terminal .....               | 6  |
| 3.1.1 | ACC Softkey .....                     | 8  |
| 3.1.2 | Espanol/English Softkey .....         | 8  |
| 3.1.3 | RUN/PROG (Run/Program) Switch .....   | 8  |
| 3.1.4 | Automatic LCD Turn Off .....          | 8  |
| 3.2   | Parameter Entry .....                 | 9  |
| 3.2.1 | Numeric Entries .....                 | 9  |
| 3.2.2 | Text Entry .....                      | 9  |
| 3.2.3 | Selection from a List .....           | 10 |
| 3.3   | Access Control .....                  | 10 |
| 3.3.1 | Key Only Mode .....                   | 11 |
| 3.3.2 | Key or Password Mode .....            | 11 |
| 3.3.3 | Password Only Mode .....              | 11 |
| 3.3.4 | Key and Password Mode .....           | 12 |
| 3.3.5 | Restricted Items .....                | 12 |
| 3.3.6 | Password System Operation .....       | 13 |
| 3.4   | Main Screen .....                     | 15 |
| 3.4.1 | Reason for the Last Stop .....        | 15 |
| 3.4.2 | Running Status .....                  | 15 |
| 3.5   | LinkNet Operator Screen .....         | 16 |
| 3.5.1 | Network Notes .....                   | 16 |
| 3.5.2 | Automatic Down Time Codes .....       | 16 |
| 3.5.3 | “Machine Idle” handling .....         | 16 |
| 3.6   | Counters .....                        | 17 |
| 3.6.1 | Configuring Production Counters ..... | 18 |
| 3.6.2 | Production Counters .....             | 18 |
| 3.6.3 | Stroke Counter .....                  | 20 |
| 3.7   | Diagnostics .....                     | 21 |
| 3.7.1 | Input Diagnostics .....               | 21 |
| 3.7.2 | Output Diagnostics .....              | 21 |
| 3.7.3 | Ethernet Diagnostics .....            | 22 |
| 3.7.4 | SD Card Diagnostics .....             | 22 |
| 3.7.5 | OIT Info Screen .....                 | 22 |
| 3.7.6 | Event Log .....                       | 22 |
| 3.8   | Job Setups .....                      | 22 |
| 3.8.1 | Store Setup .....                     | 23 |
| 3.8.2 | Recall Setup .....                    | 24 |

|       |   |    |
|-------|---|----|
| 3.8.3 | Erase Setup.....                                    | 24 |
| 4     | CONFIGURATION.....                                  | 25 |
| 4.1   | Main Configuration Screen.....                      | 25 |
| 4.2   | Machine Parameters Configuration.....               | 26 |
| 4.2.1 | “Machine Running” Input.....                        | 26 |
| 4.2.2 | “Machine Running” Timeout.....                      | 26 |
| 4.2.3 | “Setup Mode” Input.....                             | 27 |
| 4.2.4 | Log External Stops.....                             | 27 |
| 4.2.5 | Program Mode is a STOP Condition.....               | 27 |
| 4.3   | Digital Input Debounce Configuration.....           | 28 |
| 4.4   | Operator Terminal Configuration.....                | 29 |
| 4.4.1 | Top Area Display.....                               | 29 |
| 4.4.2 | Setting the Date and Time.....                      | 30 |
| 4.4.3 | Access Configuration.....                           | 30 |
| 4.4.4 | Configure Auxiliary Communications.....             | 33 |
| 5     | BACKING UP AND RESTORING THE OPERATOR TERMINAL..... | 34 |
| 5.1   | Backup Procedure.....                               | 34 |
| 5.2   | Restore Procedure.....                              | 35 |
| 5.3   | Memory Chip Swap-out Procedure.....                 | 37 |
| 6     | INSTALLATION.....                                   | 38 |
| 6.1   | Preliminary Installation Considerations.....        | 38 |
| 6.2   | Mounting the Machine Monitor.....                   | 39 |
| 6.3   | System Wiring.....                                  | 41 |
| 6.3.1 | Wiring Power for the System.....                    | 44 |
| 6.3.2 | Wiring Inputs.....                                  | 45 |
| 6.3.3 | Wiring Outputs.....                                 | 47 |

## Table of Figures

|  |    |
|--|----|
| Figure 1: Operator Terminal .....                                    | 6  |
| Figure 2: Operator Terminal Top Info Area .....                      | 7  |
| Figure 3: Example Numeric Entry Screen .....                         | 9  |
| Figure 4: Example Text Entry.....                                    | 9  |
| Figure 5: Example List Selection.....                                | 10 |
| Figure 6: Example Password Entry Sequence .....                      | 13 |
| Figure 7: Main Screen.....   | 15 |
| Figure 8: Example List Selection.....                                | 16 |
| Figure 9: Counter Screen .....                                       | 17 |
| Figure 10: Counter Group Screen .....                                | 17 |
| Figure 11: Counter Configuration Screen.....                         | 18 |
| Figure 12: Main Diagnostics Screen.....                              | 21 |
| Figure 13: Jobs Screen.....  | 23 |
| Figure 14: Store Jobs Screen.....                                    | 23 |
| Figure 15: Recall Jobs Screen.....                                   | 24 |
| Figure 16: Configuration Code Entry Screen .....                     | 25 |
| Figure 17: Main Press Control Configuration Screen.....              | 25 |
| Figure 18: Machine Parameters Screen .....                           | 26 |
| Figure 19: Digital Input Debounce Configuration Screen.....          | 28 |
| Figure 20: Operator Terminal Configuration Screen.....               | 29 |
| Figure 21: Date and Time Setting Screen .....                        | 30 |
| Figure 22: Access Configuration Screen .....                         | 30 |
| Figure 23: User Access Configuration Screen.....                     | 31 |
| Figure 24: Restrict/Unrestrict Screen.....                           | 32 |
| Figure 25: Set Config Code Screen .....                              | 32 |
| Figure 26: SD Card Slot Location .....                               | 34 |
| Figure 27: Memory Chip Location .....                                | 37 |
| Figure 28: OIT Viewing Angles .....                                  | 39 |
| Figure 29: Panel Mounting Dimensions .....                           | 39 |
| Figure 30: Enclosure Mounting Dimensions .....                       | 40 |
| Figure 31: 805-8 Machine Monitor Connectors .....                    | 42 |
| Figure 32: Open Door View of 805-8 Machine Monitor in Enclosure..... | 43 |
| Figure 33: Example Input Connections .....                           | 45 |

# 1 INTRODUCTION

The 805-8 Machine Monitor board is an option board that can be used with the Link OT805 Operator Terminal to allow the LinkNet data collection system to monitor the production statistics of a wide variety of machinery.

It is offered in two pre-built configurations. The first is with an OT805 operator terminal intended for panel mounting in an existing panel (model MM 805-8 PM). The second comes complete and ready to mount with an enclosure and 24 volt power supply (model MM 805-8 ENC).

## 1.1 Features

- Works with any machine that can provide or can be made to provide an output indicating a cycle has been made.
- Inputs allowing up to two part/batch/scrap counter groups to be driven by sensors for true part counting. Part count can also be driven based on cycles.
- Input to indicate the machine is in setup or production mode. If an output is not available from the machine, this can also be set by the operator through the screen.
- Inputs for up to 6 down time codes that can be set automatically based on status outputs from the machine.
- Inputs for up to 6 event codes that can be sent automatically based on outputs from the machine.
- Inputs for “passing through” an existing stack light with up to 4 colors. This allows down time, counters, and other conditions from the Machine Monitor to override which stack light color is active based on priority.
- Outputs for driving a stack light with up to 4 colors. This can be used to indicate the running status of the machine.
- Stop output available to inhibit machine operation when counters reach their limit or if certain inputs are configured to generate a stop.

## 1.2 Specifications

|              |   |
|--------------|---|
| Size:        | 6.25” wide, 7.25” high, 3” deep (Panel Mount Version)<br>8.3” wide, 11.5” high, 6.5” deep (Enclosure Version) |
| Input Power: | 24VDC +/- 10%, 10 Watt (Panel Mount Version)<br>90-264VAC, 47-63Hz, 30 Watt (Enclosure Version)               |
| Fuse:        | 5mm X 20mm, 0.5 Amp, 250 Volt, Fast Blow  |

## **2 DEFINITIONS AND TERMINOLOGY**

### **2.1 Stops**

There are two different kinds of stops that the module can generate. Some conditions always generate a particular kind of stop, while others are programmable by the user.

#### **2.1.1 Immediate Stop**

An “Immediate Stop” sends a signal to the control to immediately stop the press, regardless of where it is in the cycle. Note that this does NOT mean that the press will actually stop at the point where the stop was generated, as all presses take some amount of time to drop out the clutch, apply the brake, and come to a stop. For instance, if a decision to stop occurs at 175 degrees, the press may end up stopped at 200 degrees. The number of degrees a press requires to actually stop depends (among other things) on the design of the press and on stroking speed. All other conditions being equal, the faster the press is stroking, the longer it requires to stop.

#### **2.1.2 Top Stop**

A “Top Stop” sends a signal to the control to stop the press at the top of the stroke. Note that all presses take some amount of time to stop. If the control determines that it can not stop at top in the time left when it receives the stop command, it will make an additional stroke. Many high speed presses take more than 1 full stroke to stop regardless of where the stop occurs.

### 3 OPERATION

#### 3.1 Operator Terminal

Figure 1 shows the operator terminal front panel. This panel consists of a color LCD display with a touch screen and RUN/PROG key switch.

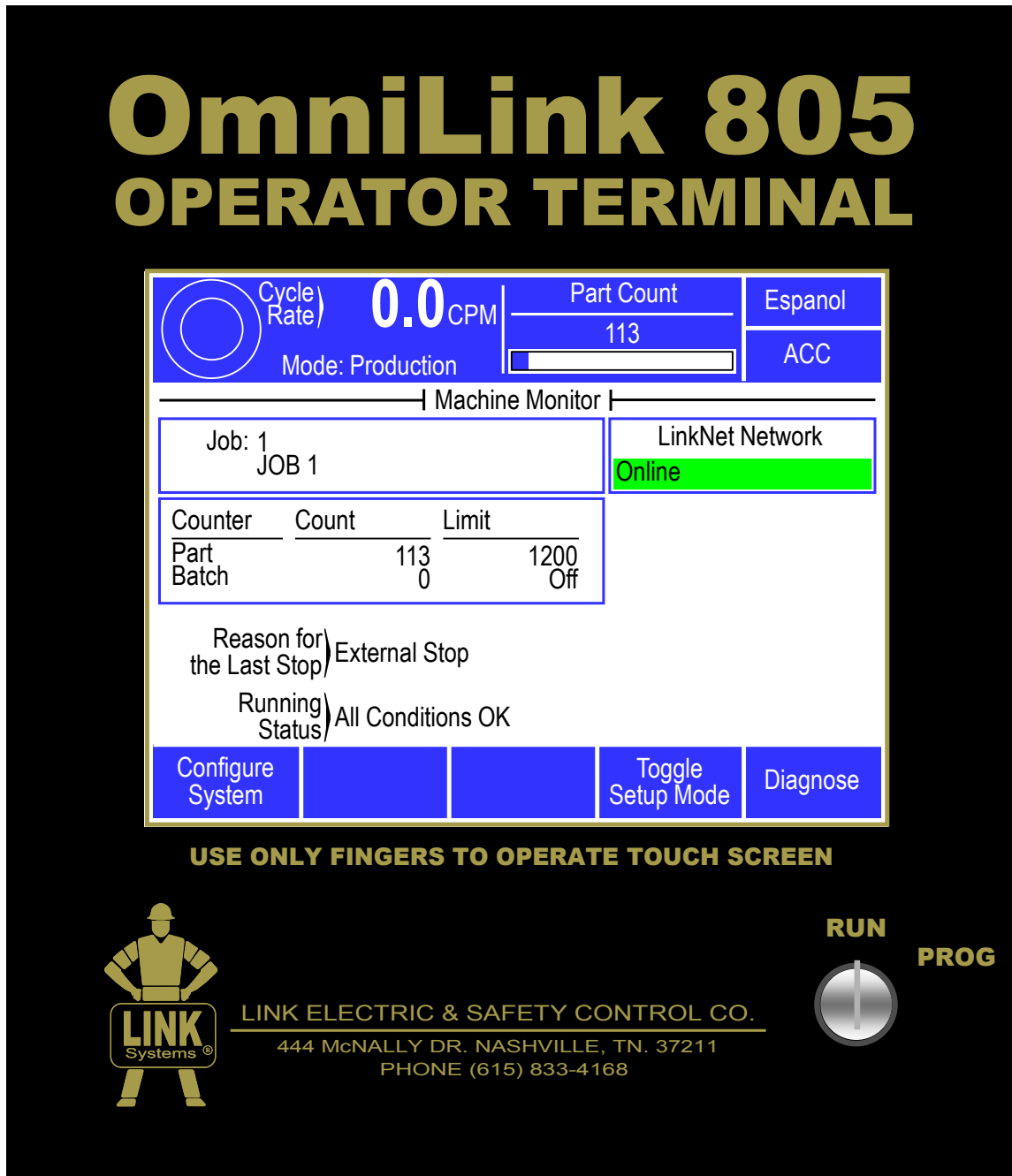
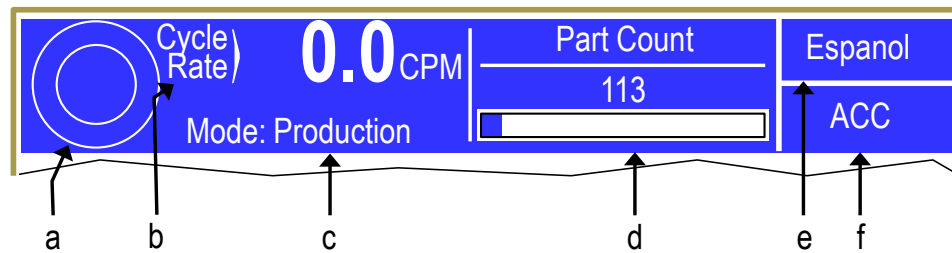

Figure 1: Operator Terminal





**Figure 2: Operator Terminal Top Info Area**

The top area of the operator terminal is used to display certain critical information and provide keys that are present regardless of what screen is being displayed. The areas are (refer to Figure 2):

- a) **Graphical Display of Machine Operation** Rotating arrows will “spin” in the circle when the machine is running.
- b) **Numeric Display of Cycles per Minute** This area provides a numeric readout of the Cycles per Minute at which the machine is currently operating.
- c) **Mode** The machine monitor can be configured to allow either an input or the operator to indicate if the machine is in a production or setup mode. The current mode is shown here.
- d) **Programmable Display Area** This area can display a variety of information, based on user selection. Some examples items available include running status, reason for the last stop, and part count (shown in the example). Press inside this area to cycle to the next available item. The operator terminal can also be configured to automatically show a particular item when the press control mode is switched from a setup mode to a production mode, and vice versa. See Section 4.4.1 for more information on configuring this area and the information items available.
- e) **Language Switching Key** This key is used to switch languages used on the operator terminal see Section 3.1.2 for more information.
- f) **Quick Access Key** This key displays the Quick Access screen. See section 3.1.1 for more information.

Areas inside the white portion of the display are shown with a blue border if that area can be selected. For example, pressing the blue bordered jobs area or the blue bordered counters area will take you to screens related to jobs or counters, respectively. Areas usually displayed along the right side and bottom of the display provide softkeys which may be selected by pressing the field. For example, pressing the “LinkNet Network” bordered area in Figure 1 will select the LinkNet operation screen.

### **3.1.1 ACC Softkey**

This is a quick access key. This key will supply direct access from any screen to the Quick Access screen. The quick access screen contains the name of the currently logged in user, the log out softkey, and access to auxiliary communications.

### **3.1.2 Espanol/English Softkey**

This changes the display language from English to Spanish or Spanish to English. If the display is currently in English, touching the **Espanol** softkey will change the display to Spanish. If the display is currently in Spanish, touching the **English** softkey will change the display to English.

### **3.1.3 RUN/PROG (Run/Program) Switch**

This is a keyed selector switch read directly by the operator terminal. The PROG (program) position can be configured to cause the machine the Stop relay to drop out until the switch is returned to the RUN position. There are several user access modes that will require the operator to turn the keyed selector to PROG position in order to modify parameters. This switch must be in the PROG position for Machine Monitor configuration, as described in Section 3.3 on page 10.

### **3.1.4 Automatic LCD Turn Off**

To increase the life of the display backlight, the backlight will automatically dim ten minutes after the machine has NOT cycled and the operator terminal detects no user activity. User activity for this purpose is defined as pressing the touch screen or operating the RUN/PROG switch. The backlight is turned back on and the ten minute timer is reset any time the touch screen is pressed on the operator terminal or the RUN/PROG key is operated.

## 3.2 Parameter Entry

Throughout the operator terminal, a standard form of data entry is employed. Parameters that can be changed are indicated by a blue border surrounding the parameter. Touch inside the blue border to edit the parameter.

### 3.2.1 Numeric Entries

A numeric parameter to be changed is selected by pressing the area on the screen that displays the parameter (surrounded by a blue border). This will bring up an editing screen similar to Figure 3.

If the parameter contains a decimal point, it will be positioned automatically by the operator terminal. The new number is entered with the numeric keypad.

The **Clear** key will clear the present number being entered, and the **Back** key will go back one number. The up and down arrow keys at the bottom right and bottom left of the numeric keypad will increment and decrement the number, respectively.

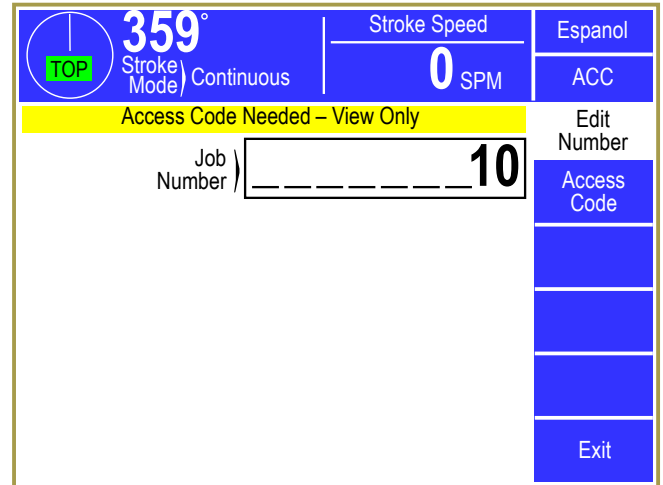

Figure 3: Example Numeric Entry Screen

Press the **Enter** key to accept the new number or abort the change by pressing the **Cancel** softkey. The number will not change from the previous value if the entry process is canceled.

### 3.2.2 Text Entry

A text parameter to be changed is selected by pressing the area on the screen that displays the parameter (surrounded by a hollow blue box). This will bring up an editing screen similar to **Error! Reference source not found.**

The editing cursor position is shown by a black background on the character the cursor is sitting on. Characters typed on the virtual keyboard will appear at the editing cursor, and the cursor will automatically advance to the next position as characters are “typed”. The cursor can also be moved by pressing the **Cursor Left** and **Cursor Right** softkeys.

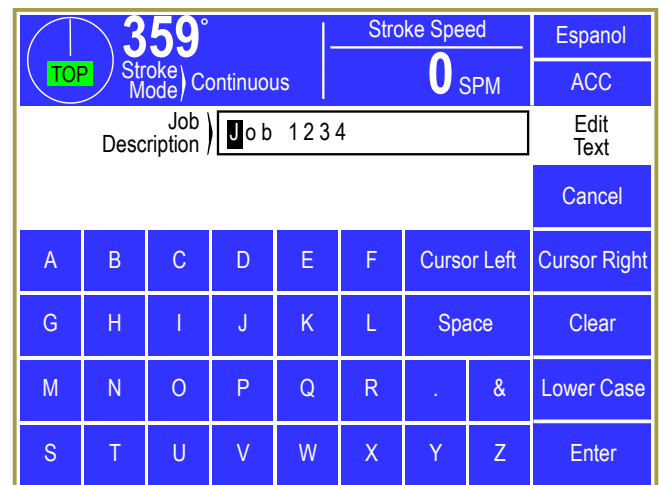

Figure 4: Example Text Entry

To erase characters, position the editing cursor at the start of the characters to erase and hit the **Space** softkey. Likewise, to change a character, position that editing cursor on that character and select the new character. The **Clear** softkey will cause all characters to be erased.

Press the **Lower Case** softkey to display a virtual keyboard with lower case letters. The **Lower Case** softkey will then change to **Numbers & Misc**. Pressing that key will change the virtual keyboard to one that has numbers and other characters on it. The **Numbers & Misc** softkey will then change to **Upper Case**. Pressing **Upper Case** brings the virtual keyboard back to its original configuration with upper case letters.

Once the text is correct, press the **Enter** softkey to keep the changes or press the **Cancel** softkey to abort the changes.

### 3.2.3 Selection from a List

Some parameters are not numeric or text, but instead are selected from a list of options. As usual, these parameters are displayed inside a hollow blue box. To change the parameter, press inside the blue box to bring up a selection screen that will be similar to that shown in Figure 5.

Note that the listed selection may all fit on one page or may take several pages to display. If more than one page is necessary to display the list, **Next Page** and **Previous Page** softkeys will be displayed as appropriate.

To choose a new selection for the parameters, press inside the blue box of the new selection. This will cause the new parameter to take effect. Press the **Cancel** softkey to exit the selection screen with no change to the parameter.

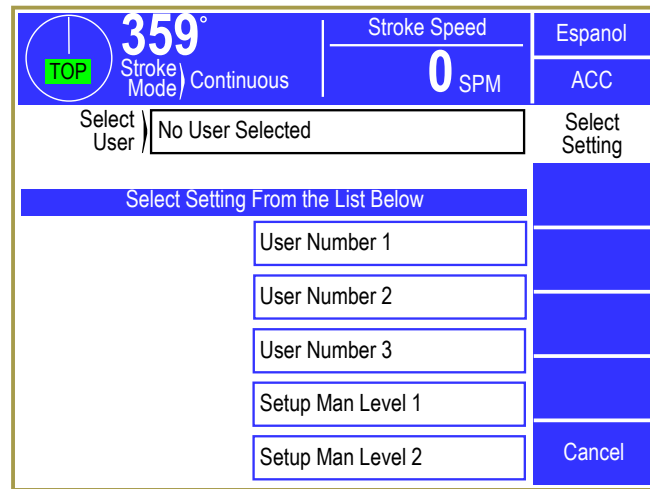

**Figure 5: Example List Selection**

### 3.3 Access Control

The Machine Monitor has layers of security relative to configuration of its hardware and software and ability to program parameters.

User (Employer) Configuration items give the user the ability to configure certain aspects of the system to meet security, information, safety, and production requirements. One of the areas of User Configuration relates to Access Control – a level of security that allows the person(s) the user designates to make certain parameter settings and reset faults. See Section 4.4.3 for the configuration of the Access Control methods discussed in this section.

The Machine Monitor has several parameters or operations that have, or can be configured to have, limited user access, i.e., by employees specified by the user (employer). The ability to perform actions such as job recall, job storage, or changing counter settings can be limited to certain personnel. The control provides several means to limit access to these parameters or operations. A complete list of the parameters and operations that can be, or are, limited as to access is listed in the Restricted Items table in Section 3.3.5. The control has the capability to make some of these limited access items available to any

operator. Access to these items can be globally un-restricted. The items which can be un-restricted to all users are also listed in the Restricted Items Table shown in Section 3.3.5.

Access to the User Configuration screens and their parameters is protected by the RUN/PROG key and the User Configuration code.

The Machine Monitor employs combinations of two different means to limit access to restricted items. These means are the RUN/PROG key switch and a user password system. The user password system assigns names and passwords to up to sixteen users. These two means can be used alone or in combination with each other. When a user employs the proper means to gain access control, he will have the ability to perform the actions and change the parameters which have been designated to his access.

There are four possible modes of operation for the access system. They are the “Key Only” mode, the “Key or Password” mode, the “Password Only” mode, and the “Key and Password” mode. The operator terminal can be configured to operate in any one of these four modes.

### **3.3.1 Key Only Mode**

The “Key Only” mode is the least complex of the four modes. This mode employs the RUN/PROG key as the means of access. Access to restricted items is granted when the RUN/PROG key is in the PROG position.

Although the “Key Only” mode has the advantage of being easy to use, it does have a disadvantage. This mode cannot give a particular user access to only some of the restricted items. When operating in this mode, any user with the RUN/PROG key will have access to all of the restricted items.

### **3.3.2 Key or Password Mode**

The key or password mode allows for either of two means to gain access to the restricted items. Access to restricted items is granted when the RUN/PROG key is in the PROG position. In addition, a user without the RUN/PROG key but with the correct password can access the restricted items that have been designated for the particular user’s access only. The system allows for passwords to be assigned to sixteen users. Each user can be assigned access to any or all of the restricted items.

The following is an example of a “Key or Password” mode operation. The RUN/PROG key is given to the die set-up personnel. A press operator is assigned a user name and password. With the password the operator is assigned permission to reset counters. In order to load a new job, the set-up personnel must use the RUN/PROG key to recall a job from job storage. Once the set-up personnel sets the job and verifies its correct operation, the operator is left to run the job.

### **3.3.3 Password Only Mode**

The “Password Only” mode allows for sixteen users. Each user can be assigned access to some or all of the restricted items. This mode does not use the RUN/PROG key.

The example listed above indicated that setup personnel required access to all restricted parameters. In the “Key or Password” mode, the setup personnel used the RUN/PROG key to gain access to all of the

restricted parameters. In the “Password Only” mode, the setup personnel can still have access to all of the restricted parameters, but the system must be configured as such. The setup personnel must be assigned a user name and password. In addition, all restricted items would be assigned access to the setup personnel.

Since there is no access to all restricted items with the RUN/PROG key, every restricted item must be assigned to at least one user. If any restricted item is not assigned to at least one of the users, it cannot be accessed. For example, if Erase Jobs is not assigned to at least one user, it will be impossible to perform the erase job function. Access to the Erase Jobs must be assigned to at least one user, before the erase job function can be performed.

### 3.3.4 Key and Password Mode

The “Key and Password” mode requires the user to have the RUN/PROG key, a user name, and a user password. Operation is basically the same as the Password only mode, except that in addition to entering the password the user must switch the RUN/PROG key to the PROG position.

Since there is no access to all restricted items with the RUN/PROG key only, every restricted item must be assigned at least one user. If any restricted item is not assigned to at least one of the users, it can never be accessed.

### 3.3.5 Restricted Items

The following table lists the restricted items name and function. Some items can be unrestricted. When an item is unrestricted, it is available to any user. Unrestricted items do not require a key or password.

| <b>RESTRICTED ITEMS</b> |  |                            |
|-------------------------|--|----------------------------|
| <b>NAME</b>             | <b>FUNCTION</b>                                    | <b>CAN BE UNRESTRICTED</b> |
| Store Jobs              | Store jobs in memory                               |                            |
| Recall Jobs             | Recall jobs from memory                            |                            |
| Erase Jobs              | Erase jobs in memory                               |                            |
| Counter Settings        | Change counter limits and turn counters off and on | Yes                        |
| Counter Change          | Change counter values                              | Yes                        |
| Counter Reset           | Reset counters that have reached their limit       | Yes                        |
| Counter Config.         | Configure counters                                 | Yes                        |
| Feed Settings           | Change feed settings                               |                            |

### 3.3.6 Password System Operation

Figure 6 displays a typical password entry sequence. This example shows the steps necessary to change the Auto Single Stroke time. This is typical for password entry for all restricted items.

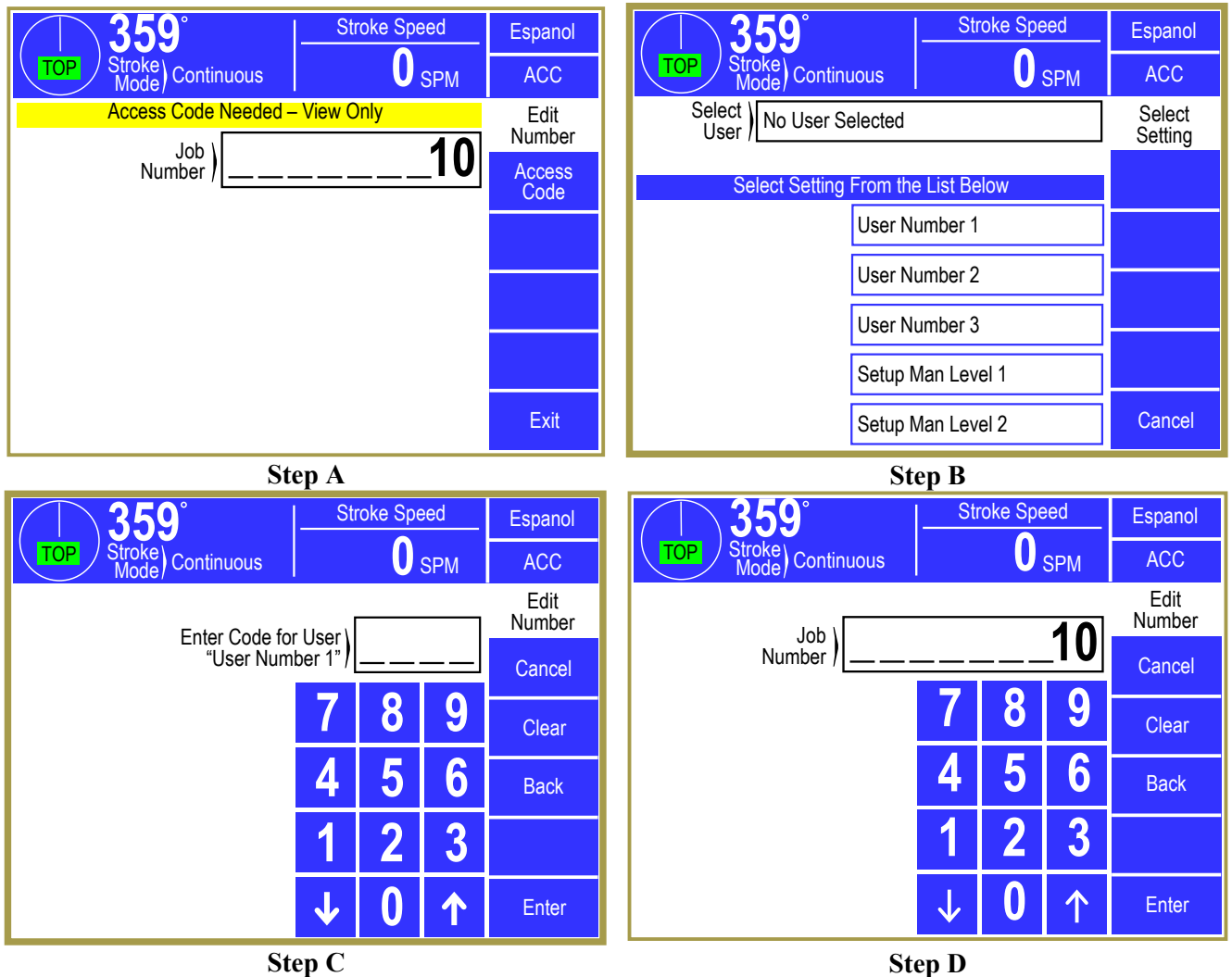

Figure 6: Example Password Entry Sequence

- Step A:** Select the restricted item. Once the parameter is selected, if restricted the display will prompt that an access code is required. The user should press the **Access Code** key.
- Step B:** A list of users that have access to this restricted item will appear. In “Step B” of Figure 6, 5 of the 16 possible users have access to this restricted parameter. The system may have several more users, but the 5 users listed on the screen are the only users that have access to Auto Single Stroke time. The user must select his user name (even if there is only one user name displayed).
- Step C:** The display will show the selected user name and request the user password as shown in “Step C” of Figure 6. The user must enter the correct password and then press the **Enter** key.

**Step D:** Upon entry of the correct password, the user will be allowed access to the restricted item. In this example, the user will be allowed to change the Job Number parameter.

After performing the steps listed above, the user will be logged in to the password system. The user will have access to all restricted items that have been designated for his access. This access will remain until the user performs a log out or until the user is automatically logged out.

The user can log out by using the **ACC** key. This key will directly switch the display to the Quick Access screen. The **Logout** soft key legend will appear along the bottom of the screen. If the operator presses this key, he will log out. He will no longer have access to the restricted items, unless he repeats steps A through D.

In addition to the manual log out, the system contains an automatic logout. The intent of automatic log out is to reduce the possibility of users other than the intended user from having access to restricted items. If there were no provisions for automatic log out and a user forgot to manually log out, all restricted items to which the user had been designated for access would be available from the log in time until power was removed from the operator terminal. This presents the possibility of users other than the intended user having access to restricted items. Automatic log out is based upon both time and press strokes. During system configuration automatic Access Timeout parameters are entered. An automatic access timeout time and automatic access timeout strokes are entered. The time entered is the amount of time after the last keystroke that will be allowed before the system will automatically log out the user. For example, if the automatic access timeout is set to 60 seconds, the user will be logged out 60 seconds after the last keystroke. If the user depresses a key before the 60 seconds have elapsed, a new 60 second cycle will be started. The number of strokes that are entered is the number of press strokes after the last keystroke that will be allowed before the system automatically logs out the user. For example, if the automatic timeout is set to 10 strokes, the user will be logged out when the press completes ten strokes after the last keystroke. If the user depresses a key before 10 strokes have been completed, a new 10 stroke cycle will be started (See Section 4.4.3.2)



### 3.4 Main Screen

Figure 7 shows the Main Operating Screen. This is the screen displayed when the unit first powers up and provides an overall view of the functions available along with general diagnostic information. From this screen the operator may select Job Setups (see “a” in Figure 7), Counters (see “b” in Figure 7), or the LinkNet operator screen. Touch inside the blue bordered area of an option to go to that screen.

In addition there are softkeys along the bottom of the screen that access the configuration area, diagnostics, and allow the operator to toggle the mode of the machine between production and setup if the machine monitor has been configured for that.

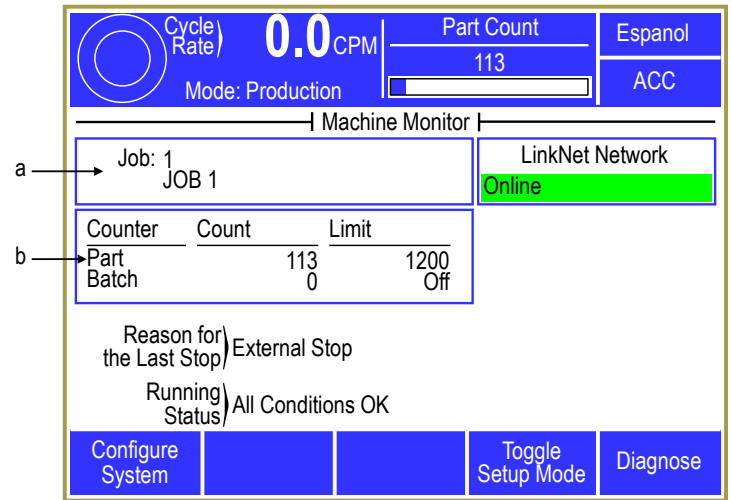

Figure 7: Main Screen

#### 3.4.1 Reason for the Last Stop

Diagnostic information is provided to show the reason the machine stopped. Once operation is initiated, the first stopping action is latched and displayed. This is done to capture transient conditions that may return to their proper state after the machine stops. This information remains latched until the machine stops again. Additional information concerning stops is stored in the Event Log (see Section 3.7.6 on page 22). Note that most of the time this will be “External Stop”, which means the Machine Monitor did not stop the press due to counters or some other internal reason, but that the machine stopped as part of its own operation. This information along with the Running Status will allow the operator to determine if and why the Machine Monitor stopped the machine, and what needs to be done to remove the stop if generated by the Machine Monitor.

#### 3.4.2 Running Status

Diagnostic information is provided to show any reason why operation may not be initiated. If multiple stop conditions exist, the clearing of a displayed stop condition will result in the display of another stop condition until no more stop conditions exist. If no stop condition exists, an *All Conditions OK* message indicates that the Machine Monitor is not asserting its Stop output. Note that the machine itself may still not be able to run due to conditions outside of the Machine Monitor.

### 3.5 LinkNet Operator Screen

The LinkNet screen allows operators to enter down time codes, view machine notes, and job notes.

Most of the screen is given to display of the down time codes configured for the machine on LinkNet. Just to their right are buttons for navigating the down time codes. Note that the **Previous Page** and **Next Page** buttons will only appear when needed. The highlight cursor (shown highlighting the Bin Change code in the example at right) can be moved by the up and down arrow keys. Pressing the **Select DTC** softkey selects the highlighted code as the current down time code.

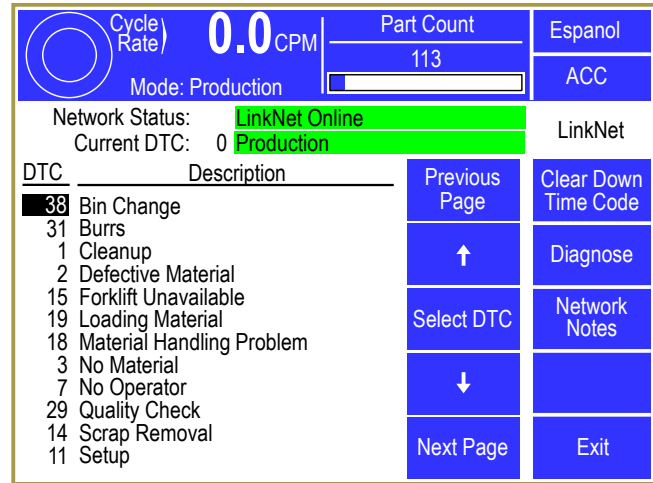

Figure 8: Example List Selection

To clear the down time code, press the **Clear Down Time Code** softkey. This will set the Current DTC back to “Production”.

#### 3.5.1 Network Notes

Pressing the **Network Notes** softkey will bring up a screen that will request the machine notes that have been entered into LinkNet from the database. In that screen, the **Job Notes** softkey will request the notes entered for the current job. Hitting that softkey again (which will have changed to **Machine Notes**) will switch back to the machine notes.

#### 3.5.2 Automatic Down Time Codes

Certain down time codes are automatic. When a new job is selected, “Job Setup” automatically becomes the current down time code. Other codes, like “Batch Count Reached” (this occurs when the “Batch Count” reaches its limit) or “Machine Idle” (see following section) will only become the current down time code if there is no currently active down time code. Automatic down time codes clear themselves the next time the machine cycles.

#### 3.5.3 “Machine Idle” handling

If the machine does not cycle within a programmable length of time (the “Idle Time Out”, which is set on LinkNet itself, not at the machine) AND there is no down time code currently entered, then the down time code will automatically change to “Machine Idle”. This code will automatically clear itself when the machine makes another cycle. The exception to this, however, is that if the setting of “Force Idle DTC Replacement” in the LinkNet configuration screen is “Yes”, then the stop relay will be active and the machine will not be able to cycle. To clear this condition, the operator must first select a down time code from the list. This code will replace the time logged under “Machine Idle”. That code can then be cleared and the machine can be cycled as usual.

This mechanism is intended to allow operators to supply a specific reason the machine has not been running when they forget to enter a down time code at the time the machine actually stopped. While the fact that the machine is not running is captured by “Machine Idle”, the specific reason is not.

### 3.6 Counters

Touch the Counter display area in the Main Screen (see “b” in Figure 7 on page 15) to go to the counter screen.

The OT805 operator terminal can support 1 or 2 counters groups. A counter group includes a part counter, a batch counter, and a scrap counter. The first counter group also has a quality counter, which is intended to allow the machine to stop every so many cycles for a quality check.

The present quantities of the part counter, batch counter, quality counter, scrap counter, and cycle counter can be viewed along with the limits of those counters that have them.

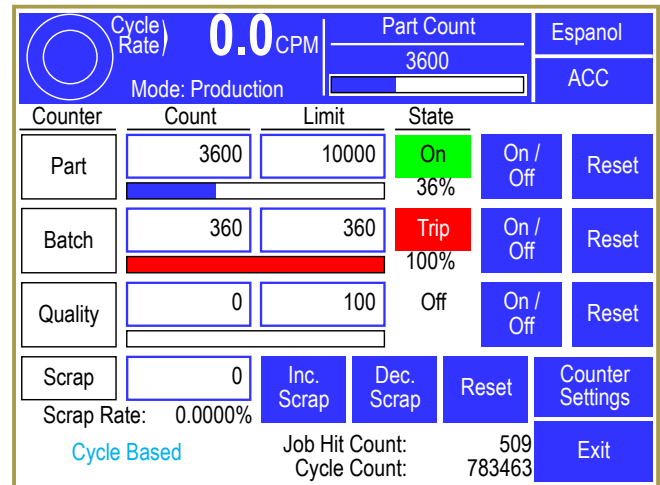

Figure 9: Counter Screen

If counters are configured for unrestricted access, anyone can change the counters and reset them. If configured for access control (described in Section 3.3 on page 10), operators must use the selected access control method to make changes.

If only one counter group is enabled, which is typical, then the Counter screen shown in Figure 9 is what will initially appear. If 2 counter groups are enabled, then initially the screen shown in Figure 10 will appear. This will show an overview of the status of both counter groups. Pressing anywhere inside of the blue bordered counter group will then display the counter screen for that counter group as shown in Figure 9.

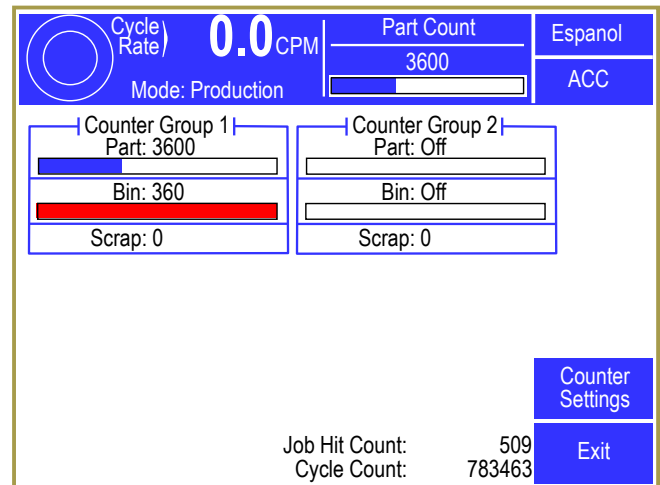

Figure 10: Counter Group Screen

Counters can be driven by cycles of the machine (Cycle Based counters) or by sensors tied to a hardware input (Sensor Based counters). The counter drive mode is indicated in the lower left corner of the counter screen. As described in the following section, cycle based counters can also be configured to count by a set amount every so many cycles and each counter group can be separately configured for cycle or sensor based counting.

### 3.6.1 Configuring Production Counters

Up to 2 counter groups can be enabled on a job by job basis. In other words, one job can have one counter group enabled, while a second job can have 2 counter groups enabled. Cycle based counter groups can also be set to increment by a particular value every so many cycles rather than incrementing by 1. To configure the counters, press the **Counter Settings** softkey in the counter screen of Figure 9.

A screen similar to Figure 11 will appear and allows each counter group to be set to cycle based counting, sensor based counting, or not used. Hitting the **Configure System** softkey in this screen will bring up a screen with only two settings –

“Maximum Number of Counter Groups” and “Enable True (Sensor Based) Part Counters”. These settings apply to the system as a whole instead of to a job. The maximum number of counter groups can be set to 1 to 2 and will affect how many counter groups are shown in the screen of Figure 11. If “Enable True (Sensor Based) Part Counters” is set to “No”, then “Sensor Based” will not be available to choose as counter group type. Both of these settings are present to allow a reduction in the number of settings presented to operators for features that are not used.

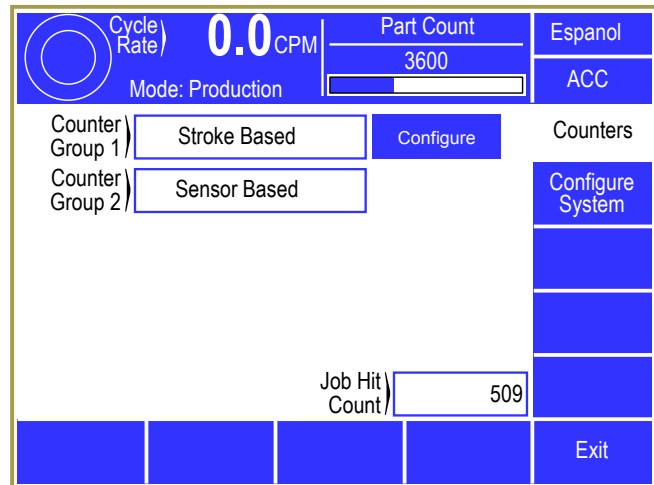

Figure 11: Counter Configuration Screen

Counter groups that are set to “Cycle Based” also have a **Configure** button shown to the right of the group (as seen in Figure 11 for Counter Group 1). When pressed, a screen will appear that allows the “Counter Increment” and “Counter Frequency” to be set. The “Counter Increment” is how much the counter will be increased when a count occurs. For instance, a job producing two parts per cycle would count by 2 every 1 cycle. The “Counter Frequency” is how often the counter should count. A lamination die might produce a part every 10 cycles. If a lamination die with 10 laminations was also a 2 out die, the “Counter Frequency” would be set to 10, and the “Counter Increment” would be set to 2. The counter would then count by 2 every 10 cycles. For typical one-out jobs, both of these values would be 1, which would count by 1 every 1 cycle.

If a counter group is set to “Sensor Based” then it is driven by its corresponding hardware inputs, PCNT1 (part count 1) and SCNT1 (scrap count 1) for counter group 1, or PCNT2 (part count 2) and SCNT2 (scrap count 2) for counter group 2. See Section 6.3.2 for how to use these inputs.

### 3.6.2 Production Counters

The three production counters provided are Part, Batch and Quality. All production counters that are turned “On” will increment as the press strokes, when the press is operating in a production mode.

**NOTE:** Cycle based Part, Batch, and Quality counters only count when not in setup mode and only if turned “On”. The cycle counter always counts regardless of mode. Sensor based counters count whenever their sensor detects a part.

When the current count reaches the programmed limit, a top stop will be issued. This stop will remain active until the counter is reset or is turned off.

The Part counter usually records the total parts made for a given process setup. The Batch counter usually records a small group of a process run, such as the number of parts that can be put into one container. The Quality counter is typically used to record the number of parts that can be made between quality inspections.

Below each production counter is a bar graph that visually indicates the progress made toward that counter's limit. When the count reaches the limit, the bar graph will change from blue to red. The percentage completion for each counter is shown to the right of the bar graph.

### 3.6.2.1 Turning Production Counters On or Off

Production counters can be turned “On” or turned “Off”. When a counter is turned “Off”, it does not increase and cannot issue a stop to the press control. A production counter is toggled “On” or “Off” by pressing the **On / Off** softkey for that counter and will be shown in the “State” column. If an access control mode (see Section 3.3 on page 10) is being used that requires a password, a user must be configured to have the “Counter Settings” permission to change this parameter.

### 3.6.2.2 Changing the Limit for Production Counters

Each production counter has a limit setting. When this limit is reached, a top stop will be issued. The slide will stop at the top of the stroke and further stroking will be prevented until the counter is reset or until the counter is turned off. If an access control mode (see Section 3.3 on page 10) is being used that requires a password, a user must be configured to have the “Counter Settings” permission to change this parameter.

### 3.6.2.3 Resetting Production Counters

A counter reset will set a production counter's current count to zero. If an access control mode (see Section 3.3 on page 10) is being used that requires a password, a user must be configured to have the “Counter Reset” permission to change this parameter.

Resetting the Part counter will also reset the Batch and Quality counters.

To reset a production counter, touch the **Reset** softkey to the right of the counter to reset. The operator terminal will ask for verification before actually resetting the counter.

### 3.6.2.4 Scrap Counter

The scrap counter can be set, incremented, and decremented manually. If the **Inc. Scrap** key is pressed, then 1 is added to the scrap count and 1 is subtracted from the part and bin counters. Likewise, if the **Dec. Scrap** key is pressed, then 1 is subtracted from the scrap count and 1 is added to the part and bin count. If the scrap count value is edited by pressing inside the blue bordered box showing the count, then the part and bin count is not affected. When the counter group is “Sensor Based”, then the scrap count is incremented each time the SCNT1 or SCNT2 (depending on counter group) hardware input is triggered without affecting the part or bin count.

### **3.6.2.5 Changing the Count for Production Counters**

The current count value of a production counter can be changed. If an access control mode (see Section 3.3 on page 10) is being used that requires a password, a user must be configured to have the “Counter Change” permission to change this parameter.

The current count is changed by touching the counter field of the desired counter and entering the new value. The numeric entry screen provides softkeys to increment or decrement the counter or a new number can be entered.

### **3.6.3 Stroke Counter**

The stroke counter increments anytime the crankshaft travels from the top of the stroke to the bottom of the stroke. Contact Link Systems service department to reset the stroke counter.

## 3.7 Diagnostics

Pressing the **Diagnose** softkey in the main screen will display the screen shown in Figure 12. Most of the information in this screen is used by Link personnel for telephone troubleshooting, but the following items are of general interest:

**Run/Program Key** – Show the position of the RUN/PROG key on the front of the operator terminal. Use this to verify that the key switch is operating correctly.

**SD Card Detected and SD Card OK** – These two lines show whether an SD Card is inserted into the SD Card slot of the operator terminal and, if inserted, whether the card has been successfully read.

**Battery Voltage** – The 805 operator terminal uses one CR2032 coin cell battery to maintain its calendar/time functions and a small amount of battery backed memory. This voltage of a new battery should be slightly more than 3 volts. This value will be shown in yellow when the voltage drops below 2.4 volts and in red when it drops below 2.19 volts. Most settings are stored in flash memory and are not lost when the battery fails, but some things that are updated very rapidly (like the current counter values) are written into battery backed RAM. If, after powering down and back up, the counter values are 0, then check this readout and replace the battery if needed.

### 3.7.1 Input Diagnostics

Pressing the **Input Diagnostics** softkey in the screen of Figure 12 will bring up a screen that shows each of the hardware inputs on the 805-8 machine monitor board. To the right of each input is the “On” or “Off” state of the input as sensed by the system, and the “On Count” of the input. The “On Count” I simply the number of times the input has turned from off to on. While not normally needed, each input has separate On and Off debounce times (see Section 4.3) and this diagnostic can be used to set those correctly when necessary.

### 3.7.2 Output Diagnostics

Pressing the **Output Diagnostics** softkey in the screen of Figure 12 will bring up a screen that shows each of the hardware outputs on the 805-8 machine monitor board. To the right of each of the output names is the On or Off state of that output. In addition, there is an **Enter Test Mode** softkey on this screen. To enter test mode, press this softkey and enter the configuration code when prompted. All outputs will turn off and a **Toggle** softkey will appear to the right of each output. Pressing the **Toggle** key for an output will toggle it between off and on. This will allow testing the connection or operation of whatever the output is tied to.

Once test mode is exited (by pressing the **Exit Test Mode** softkey or simply exiting the screen), the outputs will return to their normal function.

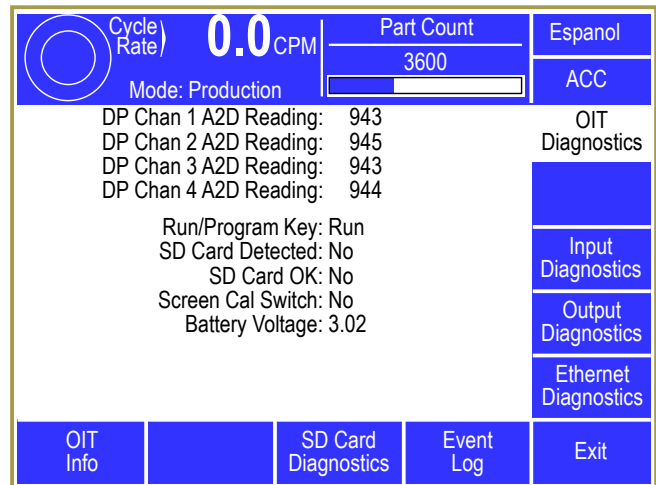

Figure 12: Main Diagnostics Screen

**WARNING:** The configuration code is required before entering test mode to prevent accidental or unauthorized operation of the outputs. *Before toggling outputs make sure to understand the effects of turning that output off or on for the machine to which it is connected.* Outputs may cause machine operations to occur or voltages to appear that are hazardous to personnel.



### 3.7.3 Ethernet Diagnostics

Pressing the **Ethernet Diagnostics** softkey in the screen of Figure 12 will bring up a screen that shows information about the current state of the Ethernet connection. The information near the top of the screen shows the Host Name of the operator terminal and whether or not there is an active Ethernet connection. An active connection is when there is an Ethernet cable plugged into the Ethernet jack AND the other end of the cable is connected to an active hub or switch. Most of the other information shown on this screen are standard Ethernet settings that can be used by information technology personnel to verify proper operation on the company network. In particular, the IP Address is often necessary to know to make connections to the operator terminal from things such as Modbus masters and from LinkNet data collectors.

### 3.7.4 SD Card Diagnostics

Pressing the **SD Card Diagnostics** softkey in the screen of Figure 12 will bring up a screen that shows information about any SD Card that is inserted in the SD Card connector, if any. For the most part the information displayed here is useful for Link personnel to use when troubleshooting over the telephone. The exception to this is the **Backup / Restore** softkey. See Section 5 for information on backing up and restoring the terminal.

### 3.7.5 OIT Info Screen

Pressing the **OIT Info** softkey in the screen of Figure 12 will bring up a screen that shows information about the operator terminal hardware, and its software version.

### 3.7.6 Event Log

Pressing the **Event Log** softkey in the screen of Figure 12 will bring up a screen that shows timestamped events, primarily information about why the operator terminal generated a stop. In the case of the machine monitor this will usually be counter stops.

## 3.8 Job Setups

In the Link operator terminal, all pertinent information for the current job such as counter settings and others can be stored for later use as a block of information called a "job setup". Since this programmed data may change from job to job as different tools or fixtures for the machine are changed, saving a job setup prevents the operator from having to manually change all this information. The operator can



simply recall the appropriate job setup which was previously stored and the machine is ready to run. The OT805 operator terminal can store 100 different job setups.

Touch the current Job display area in the Main Screen (see “a” in Figure 7 on page 15) to select the Job Setups screen shown in Figure 13.

The jobs can be arranged on the display in either alphabetical order by their description or in numerical order by job number by touching the **Sort By Number / Sort By Descrip.** softkey (this softkey toggles between the two descriptions).

This screen has softkeys to Recall a job setup, Store a job setup, or Erase a job setup as described in the following sections.

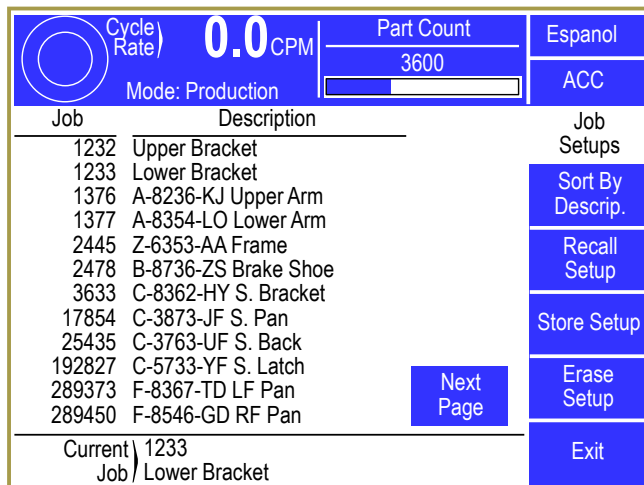

Figure 13: Jobs Screen

### 3.8.1 Store Setup

From the Jobs screen shown in Figure 13, touch the **Store Setup** softkey to display the screen shown in Figure 14. The Store Setup screen allows the user to place all settings for the job currently in use into the internal file storage area.

The user must have access control to change the parameters on this screen or store the job. Access control is described in Section 3.3 on page 10. If an access control mode is being used that requires a password, a user must be configured to have the “Store Jobs” permission to store a job.

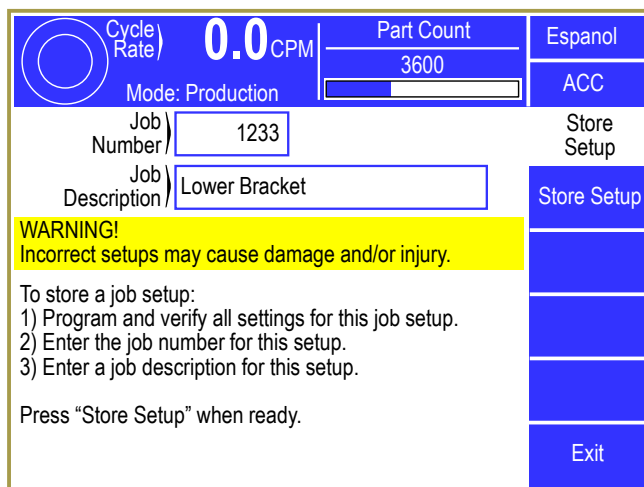

Figure 14: Store Jobs Screen

The screen shown in Figure 14 allows the user to enter a new number under which the job will be stored by selecting the “Job Number” field. This number must be unique to store to a new job. Entering a number already in use allows the current settings to replace the previous ones for that job number. After entering a job number, the “Job Description” field can be selected to enter an alphanumeric description. Press the **Store Setup** softkey in order to save the current job information in the internal file system under the job number and job description displayed. The operator terminal automatically returns to the Job Setups screen.

**NOTE:** The “Current Job” is actually a separate job in the operator terminal. Changes made to the current job are *NOT* automatically made to the stored job. The user must intentionally store the new settings over the old job number if those settings are to be saved permanently under that job number. The “Current Job” does keep the changes that are made until a new job is recalled over it. This allows the stored job to keep a set of baseline parameters that may need minor tweaks (for material thickness variation, for example).

### 3.8.2 Recall Setup

From the Job Setups screen shown in Figure 13, touch the **Recall Setup** softkey to display the Recall Setup screen shown in Figure 15. If enough jobs are stored to take more than one page to display then **Next Page** and **Previous Page** softkeys will allow additional pages of jobs to be displayed to locate the page that the job is on.

Use the up and down arrow keys to move the highlight cursor to the desired job and then touch the **Recall Selected** softkey to recall the job.

If the job number to recall is already known, the **Recall By Job Num** softkey allows the user to enter the desired job number directly into the operator terminal, which automatically searches the file system and, if located, retrieves the job.

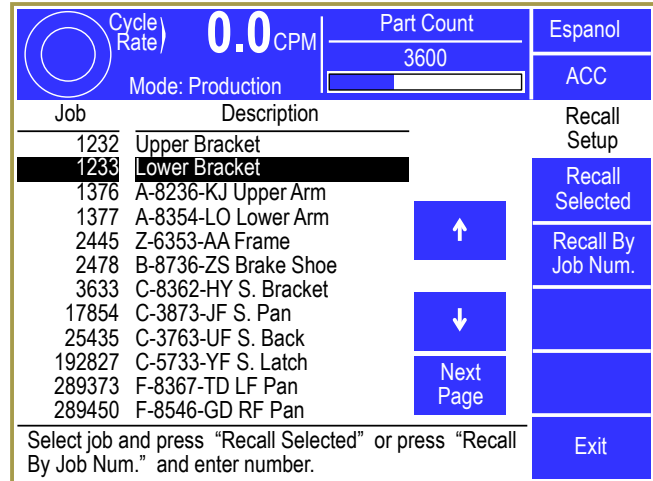

**Figure 15: Recall Jobs Screen**

For either recall method described above, the operator terminal will ask for confirmation from the user before actually recalling the job.

The user must have access control to perform a job recall. Access control is described in Section 3.3 on page 10. If an access control mode is being used that requires a password, a user must be configured to have the “Recall Jobs” permission to recall a job.

### 3.8.3 Erase Setup

From the Jobs screen shown in Figure 13, touch the **Erase Setup** softkey to display the Erase Jobs screen. The Erase Jobs screen allows the user to select the job with arrow keys or enter the job number that is to be erased in the same manner as the Job Recall screen does (with **Erase Selected** and **Erase By Job Num.** softkeys).

The operator terminal will ask for confirmation from the user before actually erasing the job.

The user must have access control to perform a job erase. Access control is described in Section 3.3 on page 10. If an access control mode is being used that requires a password, a user must be configured to have the “Erase Jobs” permission to erase a job.

## 4 CONFIGURATION

### 4.1 Main Configuration Screen

The 805-8 Machine Monitor has multiple layers of security relative to configuration of its hardware and software and the ability to program parameters.

The main level of security are User (Employer) Configuration items that give the user the ability to configure certain aspects of the system to meet the security, information, and production requirements or preferences for the machine on which the monitor is used. The configuration screens are accessible only from the Main screen shown previously in Figure 7 on page 15. The **Configure System** softkey only appears on the Main screen when the RUN/PROG switch is in the PROG position and, when touched, the display will ask for the Configuration code as shown in Figure 16. This Configuration code is user programmable. The original code is sent from the factory to a designated person when the control is ordered. The user has the option of keeping the original code or changing to another. The user must record and protect the current code. This code should only be provided to qualified personnel with knowledge of any requirements for items to be configured.

If the User Configuration code is entered correctly, the selection softkeys shown in Figure 17 are presented. Touching a softkey will result in the display of the associated configuration screen.

Once access to the configuration screen has been granted, the RUN/PROG switch may be switched back and forth between PROG and RUN. Switching to RUN will not kick the user out of the configuration area, but most parameters cannot be changed unless the key is placed in the PROG position. Pressing the **Exit** softkey will return the display to the Main screen.

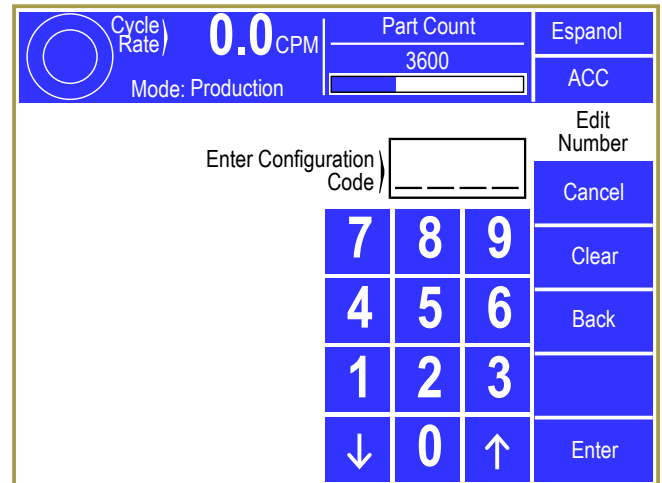

Figure 16: Configuration Code Entry Screen

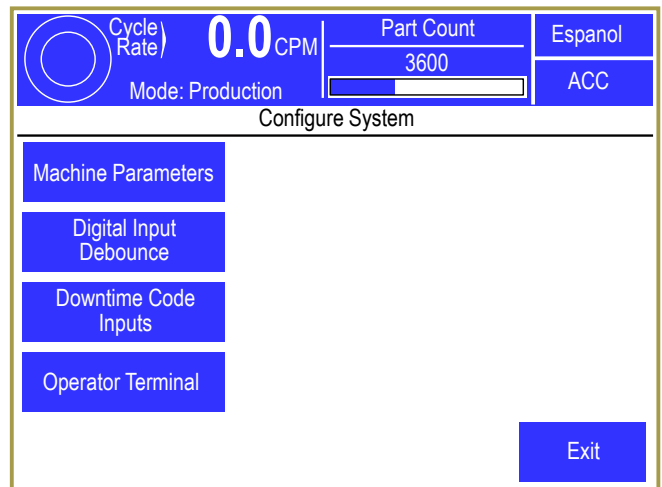

Figure 17: Main Press Control Configuration Screen

## 4.2 Machine Parameters Configuration

The Machine Parameters screen is accessed by touching the **Machine Parameters** softkey in the Main Configuration screen (see Figure 17 on page 25).

The parameters shown in Figure 18 are User Configuration parameters typically set when the Machine Monitor is installed.

### 4.2.1 “Machine Running” Input

This parameter controls which input will be used to indicate the machine is actively running. While “Running”, the circular indicator at the upper left corner of the screen will display rotating arrows.

Some machines may have outputs that indicate when they are actively running, while others may only indicate they have made a cycle. The choices for this setting are:

The screenshot shows the Machine Parameters screen with the following details:

- Cycle Rate:** 0.0 CPM
- Part Count:** 3600
- Mode:** Production
- Language:** Espanol
- ACC:** ACC
- Machine Running Input:** CYCLE Input
- Machine Running Timeout:** 500 ms
- Setup Mode Input:** Operator Selected
- Log External Stops:** Off
- Program Mode is A STOP Condition:** Yes
- Machine Parameters:** Machine Parameters
- Exit:** Exit

**Figure 18: Machine Parameters Screen**

**CYCLE Input** - In this mode, as soon as the CYCLE input turns On, the machine is considered to be running. It will be considered “running” for the “*Machine Running*” Timeout time. If the machine usually runs at 60 cycles per minute, then each cycle should last 1 second (or 1000 milliseconds). Setting the “*Machine Running*” Timeout to a little longer than that, perhaps 1200 milliseconds, would cause the machine monitor to consider the machine to be “running” continuously because the cycle input would retrigger the timeout once a second. When the machine goes longer than 1200 milliseconds without a CYCLE input, then the machine is no longer “running”. Use this mode when the machine does not have an output that stays On while it is running.

**RUN Input** - In this mode, the machine is “running” as long as the RUN input is On. Like the case when using the CYCLE input, the “*Machine Running*” Timeout is also used with this input. The timeout can be used to allow an output that pulses when the machine is running to act as if it stays on.

### 4.2.2 “Machine Running” Timeout

As described in the previous section, this setting works in conjunction with the “*Machine Running*” Input parameter to allow intermittent inputs to be treated as a continuous input to indicate the machine is “running”.

### 4.2.3 “Setup Mode” Input

This parameter controls how, or if, the machine monitor is told that the machine is in a setup mode, rather than a production mode. The choices are:

*Not Used* - Indicated the machine does not have, or does not use a setup mode. This might be the case with certain single-use machines that are dedicated to a particular purpose.

*SETUP Input* - Uses the SETUP hardware input to indicate the machine is in setup mode. Use this when a hardware output is available from the machine.

*Operator Selected* - When no output from the machine is available to drive the SETUP hardware input, then the operator can indicate the current mode (setup or production) by using a **Toggle Setup Mode** softkey on the main screen of the operator terminal as shown in Figure 7. The current mode (Setup or Production) is displayed in the upper left corner of the operator terminal (see “c” in Figure 2).

### 4.2.4 Log External Stops

The event log records a timestamped reason each time the machine stops. In the case of the Machine Monitor most of these stops will likely originate from the machine and not from the monitor. In these cases, the machine monitor only knows that it did not generate the stop and records those as “External Stop”. Since the simple fact that the machine stopped may not be diagnostically useful, if you set this parameter to “No” then only stops actually generated from the Machine Monitor (such as counters reaching their limit) will be recorded in the event log. If this is set to “Yes” then “External Stop” will also be logged.

### 4.2.5 Program Mode is a STOP Condition

If set to “Yes”, then when the Machine Monitor RUN/PROG switch is in the PROG position, then the Machine Monitors STOP output relay will open up, preventing the machine from running or stopping the current cycle – assuming the STOP relay is properly tied into the machine circuit.

### 4.3 Digital Input Debounce Configuration

The Digital Input Debounce screen is accessed by touching the **Digital Input Debounce** softkey in the Main Configuration screen (see Figure 17 on page 25). In this screen the debounce characteristics of each input can be set.

On the screen each input is briefly described followed by how it's labeled on the board itself in parentheses. Press the **Next Page** and **Previous Page** softkeys to see all the inputs

The *Input "On" Debounce Time* is the amount of time in milliseconds that the input must be continuously on before the Machine Monitor will treat it as "On".

|                        | Input "On"<br>Debounce Time | Input "Off"<br>Debounce Time |                |
|------------------------|-----------------------------|------------------------------|----------------|
| Cycle (CYCLE)          | 2 ms                        | 10 ms                        | Espanol<br>ACC |
| Setup Mode (SETUP)     | 2 ms                        | 10 ms                        | Configure      |
| Running (RUN)          | 2 ms                        | 10 ms                        |                |
| Part Count 1 (PCNT1)   | 2 ms                        | 10 ms                        |                |
| Scrap Count 1 (SCNT1)  | 2 ms                        | 10 ms                        |                |
| Part Count 2 (PCNT2)   | 2 ms                        | 10 ms                        |                |
| Scrap Count 2 (SCNT2)  | 2 ms                        | 10 ms                        | Next Page      |
| Part Count Aux (PCAUX) | 2 ms                        | 10 ms                        | Exit           |

**Figure 19: Digital Input Debounce Configuration Screen**

Likewise, once the input is considered to be "On", the *Input "Off" Debounce Time* is the amount of time in milliseconds that the input must be continuously "Off" before the Machine Monitor will treat it as "Off".

The default values will normally work just fine, but in certain cases they may need to be adjusted. For example, if an output is available on a machine that is subject to interference or for some reason flickers "On" (It is common for electromechanical relays contacts to "bounce" when they turn "On" or "Off"), you may want to increase the *Input "On" Debounce Time* so that the Machine Monitor doesn't detect the input until it has been "On" for 20 milliseconds. This would prevent the example bouncy relay output from being sensed as turning "On" multiple times. The Input diagnostic screen is handy for detecting these kinds of conditions and testing the settings here. The "State" and "On Count" in that screen can be used to make sure no false "On" is detected.

In an opposite example, it may be that a sensor used to detect something flickers "Off" due to machine vibration or some other condition. The *Input "Off" Debounce time* could be set so that the input has to "Off" continuously for 500 milliseconds before it is treated as "Off".

**NOTE:** Debounce values will affect the maximum rate at which things can be detected. For instance, if a part count input is set up with a 250ms "On" debounce and a 750ms "Off" debounce, then at most 60 parts per minute can be detected (250ms on plus 750ms off = 1000ms or 1 second for the input to turn on and then off).

## 4.4 Operator Terminal Configuration

The Operator Terminal configuration screen is accessed by touching the **Operator Terminal** softkey in the Main Configuration screen (see Figure 17 on page 25).

The screen shown in Figure 20 can be used to configure the operator terminal to display specific default information in the “top info area” that appears in all operator screens.

The operator can select any of the “Top Area Display” items by pressing the top info area, but the selection made here will be the default at power up. This screen can also be used to set the real time clock if necessary.

|                                  |                   |            |                      |
|----------------------------------|-------------------|------------|----------------------|
| Cycle Rate                       | 0.0 CPM           | Part Count | Espanol              |
|                                  |                   | 3600       | ACC                  |
| Mode: Production                 |                   |            | Operator Terminal    |
| Setup Mode Top Area Display      | Part Count        |            |                      |
| Production Mode Top Area Display | Part Count        |            |                      |
| Date: 06/23/2009                 | Set Date and Time |            | Access Config        |
| Time: 10:40:35 AM                |                   |            | Auxiliary Comm Setup |
| Display Brightness               | 70%               |            | Exit                 |

**Figure 20: Operator Terminal Configuration Screen**

### 4.4.1 Top Area Display

The center section of the top display area can be configured to show the following items:

- Part Count
- Current Status
- Reason for Last Stop

The displayed item can change when the stroking mode is changed. The user can chose the item that is to be displayed in Setup mode and the item that is to be displayed in Production mode.

Note also that touching the “top info area” in any screen will cycle through the available information items that are not currently shown. This allows the operator to conveniently see any of the items without having to change them in this screen. The next time the mode is changed, however, the item will be shown as configured here again.

## 4.4.2 Setting the Date and Time

The operator terminal contains a real time clock. To set the time and date, press the **Set Date and Time** softkey shown in Figure 20. The screen of Figure 21 will be displayed. Set the date and time to the desired values and then press the **Enter** softkey to keep the changes. Note that the date and time change only occur at the time the **Enter** softkey is actually pressed. Press the **Cancel** softkey to abandon any changes and keep the current date and time.

**Figure 21: Date and Time Setting Screen**

## 4.4.3 Access Configuration

As described in Section 3.3 on page 10 the user must gain Access Control in order to perform certain operations and change certain parameters. This access control can be obtained by two means, RUN/PROG key or a user password system. These two means can be used alone or in combination with each other.

Press the **Access Config** softkey from the Operator Terminal Configuration screen (see Figure 20) will display the Access Configuration screen shown in Figure 22.

In addition to some basic parameters that determine how access control will work, this screen lists the “Users” that can operate the system. Note that “Users” are ignored if the “Access Mode” is set to “Key Only”. The **Next Page** and **Previous Page** softkeys are used to page through up to 16 possible “Users”.

| Num | User Description | Used | Action |
|-----|------------------|------|--------|
| 1   | User 1           | Yes  | Edit   |
| 2   | User 2           | No   | Edit   |
| 3   | User 3           | No   | Edit   |
| 4   | User 4           | No   | Edit   |

**Figure 22: Access Configuration Screen**

The following sections discuss the parameters and features of this screen.

### 4.4.3.1 Access Mode Configuration

There are four access modes. These are “Key and Code”, “Code Only”, “Key or Code”, and “Key Only”. These modes are explained in Section 3.3 on page 10.



### 4.4.3.2 Access Timeout and Access Strokes

When users gain access by using a password, they remain logged in until they manually log out or are automatically logged out. See Section 3.3.6 on page 13. Automatic log out can be either time based or stroke based.

The timed log out is based upon the time between keyboard activity. If the user does not press any key on the operator terminal within the time programmed, the control will automatically log out the user. The “Access Timeout” parameter sets this time. A time of 0 seconds turns off the timed log out and the system will not automatically log out a user based on time (but manually logging out or stroke based automatic logout will still function).

The “Access Strokes” parameter sets the number of press strokes between keyboard activity that the system will allow before automatically logging out the user. A value of 0 strokes turns off the stroke based automatic log out (but manually logging out or timed based automatic logout will still function).

### 4.4.3.3 Store Job Code

The “Store Job Code” is an optional access code that can be required before an operator is allowed to store a job and is used ONLY when “Access Mode” is “Key Only”. This allows only trusted operators to overwrite a job setup while still allowing other operators to recall job setups and perform other operations. Since the purpose of this code is primarily the protection of known good job setups, it also applies to job erase operations. A setting of “0” will disable this function, and anyone with the RUN/PROG key will be able to store and erase job setups.

### 4.4.3.4 Edit User

The control allows for up to sixteen users to have the ability to gain access control. Each user is assigned a name, a password, and various permissions. Touch the **Edit** softkey to the right of a user in the Access Configuration screen (shown in Figure 22) to display the User Configuration screen shown in Figure 23.

This display provides the following information:

- User name/description
- User’s current password
- Whether or not the User is “Used”
- A listing of permissions for this user.

The screenshot shows the 'User Access Configuration Screen' with the following data:

|                               |            |                |      |               |
|-------------------------------|------------|----------------|------|---------------|
| Cycle Rate                    | 0.0 CPM    | Part Count     | 3600 | Espanol       |
| Mode                          | Production |                |      | ACC           |
| User Description              | User 1     |                |      | Access Config |
| User Code                     | 1          | Used           | Yes  |               |
| Items in RED are unrestricted |            |                |      |               |
| Permissions                   |            |                |      |               |
| Store Jobs                    | Yes        | Counter Change | Yes  |               |
| Recall Jobs                   | Yes        | Counter Reset  | Yes  |               |
| Erase Jobs                    | No         | Counter Config | No   |               |
| Counter Settings              | Yes        | Feed Settings  | Yes  | Exit          |

Figure 23: User Access Configuration Screen

The user can be enabled or disabled. When a user is enabled (“Used” set to “Yes”), the user’s name will appear on a list of possible users that may obtain access control. When a user is disabled (“Used” set to “No”), the user’s name will not appear on a list of possible users that may obtain access control.

Each user can be granted permission to access certain restricted items. A list of these items is shown in Section 3.3.5 on page 12. If a restricted item is configured with a “Yes”, the user can obtain access to that item. If the restricted item is configured with a “No”, the user cannot obtain access to that item.

#### 4.4.3.5 Restrict/Un-Restrict Access

In addition to the user access system, certain items can be made available to any operator as shown in Figure 24. An example of this would be to allow any operator to reset the production counters. Any item marked as “Yes” can be changed by an operator without the RUN/PROG key or an access code. Note that this is true even if the “Access Mode” is in one of the modes that require a code and the user permission for the same setting is marked to deny access. These settings will override any other restriction.

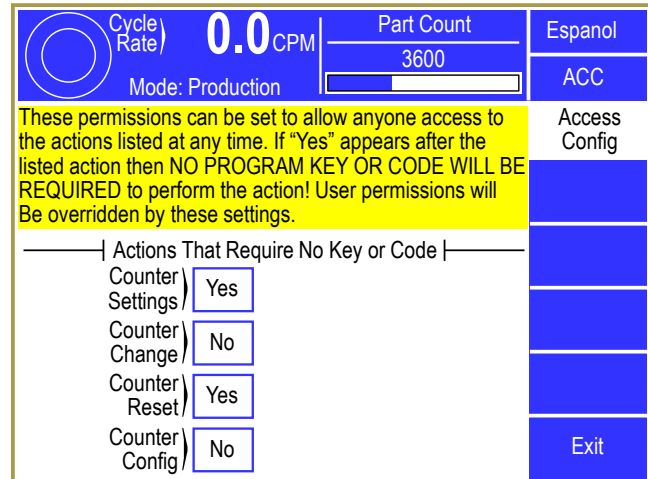

Figure 24: Restrict/Unrestrict Screen

#### 4.4.3.6 Setting the Configuration Code

Selecting the **Set Config Code** softkey in the Access Configuration screen, will display the Configuration Code screen shown in Figure 25. This screen allows the Configuration Code to be changed. This is the configuration code that protects Top Stop Calibration, Machine Parameters, Lubrication Systems Configuration, Operator Terminal Configuration, Restricted Programmable Limit Switch Setting, Names and Messages, Counter Configuration, Tonnage Monitor Configuration, Die Protection Configuration, and Auto Setups Configuration. It is imperative that this code be given only to authorized personnel who are familiar with the control and with the consequences of incorrect parameter settings.

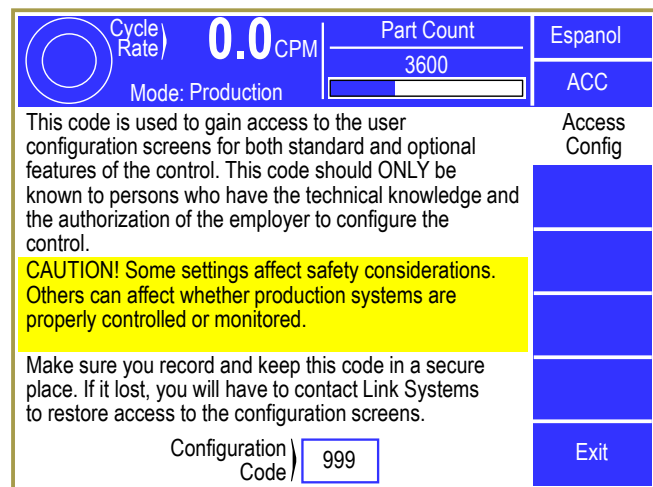

Figure 25: Set Config Code Screen

The configuration code is set at the factory. It is suggested that this code not be changed unless the security of the configuration code has been jeopardized. If a configuration code has been obtained by personnel who do not require access to the configuration parameters, it must be changed. When this code is changed, the previous code will no longer be valid. The value of the new code should be documented and stored in a secure place.

If a current code value is lost, the factory must be consulted for a recovery procedure.

#### 4.4.4 Configure Auxiliary Communications

The **Auxiliary Comm Setup** softkey provides access to the configuration screens for the communication options. These options include serial communication ports for interfacing to electronic servo feeds, auxiliary equipment (such as PLCs), a laptop interface for downloading messages, and a network interface. See the manual pertaining to the particular device that is connected for communication.

## 5 BACKING UP AND RESTORING THE OPERATOR TERMINAL

The OmniLink 805 Operator Terminal (OIT) stores most of the settings of the system to which it is attached in its internal storage. This section is intended to give maintenance personnel the necessary procedures to back up and restore the memory from an OIT to a secure digital card. Backups that are created can be used to restore the settings stored in the backup to the same OIT, or to a different OIT in cases where the original OIT must be replaced due to damage.

A “secure digital” (SD) flash card is used to store the backup data. This type of flash card is commonly available from stores such as Radio Shack, Best Buy, Wal-Mart, Target, etc. Since a single backup for an 805 operator terminal will take up less than 64KB of space, even the smallest capacity SD cards will have more than enough space for backups. The location of the SD card slot on the back of the OIT is shown below in Figure 26.

### 5.1 Backup Procedure

To back up the OIT, first go to the backup / restore screen. To get there:

- From the main screen (the screen shown when the operator terminal is first turned on), press the **Diagnose** softkey.
- Press the **SD Card Diagnostics** softkey.
- Press the **Backup / Restore** softkey. Note that this key will not appear unless the RUN/PROG key is in the PROG position.
- The operator terminal will ask for the Configuration Code. Enter the code and the Backup/Restore screen will be shown.

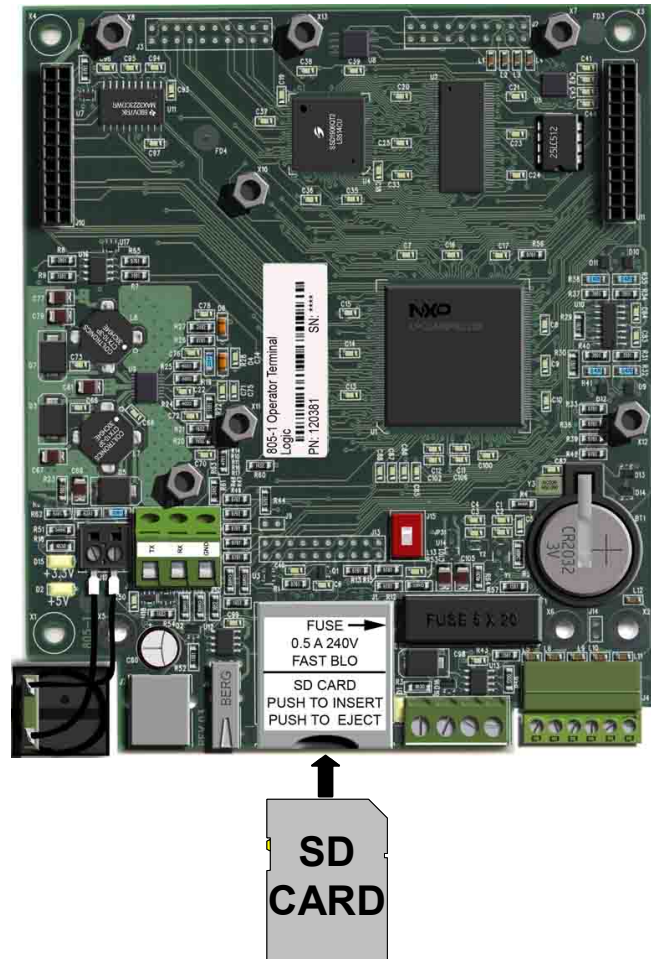

Figure 26: SD Card Slot Location

The screen will indicate whether an SD card is present and, if so, whether there are any backup files on it.

To make a backup file:

- Press the **Backup OIT** softkey. Note that this key will only be present if the RUN/PROG key is in the PROG position AND an SD Card is inserted in the SD Card slot of the OIT.
- A new screen will appear that will allow a short description of the backup to be entered. In addition to this, the serial number of the OIT and the date and time (according to the OIT clock) will automatically be stored with the backup.

- This screen will also show a warning if a backup file for this OIT is already present. Multiple OITs can be backed up on one SD Card, but only one backup file from *each* OIT can be stored on a given card.
- After a description has been entered, press the **Execute Backup** softkey to start the backup.
- A progress bar at the bottom of the screen will indicate the status of the backup, and after completion a message will appear indicating the success or failure of the operation.
- Hit Exit to go back to the main backup / restore screen.

The main backup / restore should now indicate that it has found a backup file for this OIT.

**NOTE:** One SD Card can store backup files from many different OT805 operator terminals, but only one backup file from each *individual* OT805 can be stored on a card. To make multiple backups of a single OT805, use a different card for each backup.

## 5.2 Restore Procedure

**WARNING:**  Unlike backups, which make no changes, a restore of a backup file will completely replace the settings and information contained in the operator terminal. Make absolutely sure you restore the intended backup file!

To restore the OIT, first go to the backup / restore screen. To get there:

- From the main screen (the screen shown when the operator terminal is first turned on), press the **Diagnose** softkey.
- Press the **SD Card Diagnostics** softkey.
- Press the **Backup / Restore** softkey. Note that this key will not appear unless the RUN/PROG key is in the PROG position.
- The operator terminal will ask for the Configuration Code. Enter the code and the Backup/Restore screen will be shown.

The screen will indicate whether an SD card is present and, if so, whether there are any backup files on it. The screen will also indicate whether there is a backup file that was originally made from the same operator terminal and/or whether backup files exist that were made from different operator terminals.

Backups made from the same operator terminal show up in the main backup / restore screen. The user entered description is shown along with the date and time that the backup was made. To restore a backup file to the same operator terminal that made it:

- From the main backup / restore screen press the **Execute Restore** softkey. Note that this key will not appear unless the RUN/PROG key is in the PROG position and an SD Card is inserted that has a backup file that was created from the same operator terminal.

- A warning screen will appear that explains the original information in the operator terminal will not be recoverable after the restore is started. Press the **Execute Restore** softkey in this screen and a progress bar at the bottom of the screen will show the progress of the operation. ***Do not remove power from the unit until the operation is finished.***
- Press the **Exit** softkey and the operator terminal will reboot with the new settings.

Sometimes, such as when the original operator terminal has been damaged, it may be necessary to restore a backup file made from a different operator terminal. To do this:

- From the main backup / restore screen press the **View Other Backups** softkey. Note that this key will not appear unless the RUN/PROG key is in the PROG position and an SD Card is inserted that has a one or more backup files that were created from different operator terminals.
- A screen will appear with the backup files available to choose from. These files are listed with the serial number of the operator terminal that made them, the date and time they were made, and the user entered description of the backup. Select a file from this screen by pressing the name of the file to restore.
- A warning screen will appear that explains the original information in the operator terminal will not be recoverable after the restore is started. Press the **Execute Restore** softkey in this screen and a progress bar at the bottom of the screen will show the progress of the operation. ***Do not remove power from the unit until the operation is finished.***
- Press the **Exit** softkey and the operator terminal will reboot with the new settings.

## 5.3 Memory Chip Swap-out Procedure

In cases where an operator terminal is being swapped out with another, but there is no backup file available or the only one available is badly out of date, the memory chip that contains the information stored on the operator terminal may be moved to new terminal. Figure 27 shows the location of the memory chip. Note that it will be necessary to remove the 805-8 board to get access to the chip.

***Before starting this procedure, make sure all power is removed from both operator terminals.***

Carefully remove the chip from its socket in the operator terminal being replaced. If using a small screwdriver to assist in the removal, be careful to place the screwdriver between the chip and the socket rather than the socket and the circuit board.

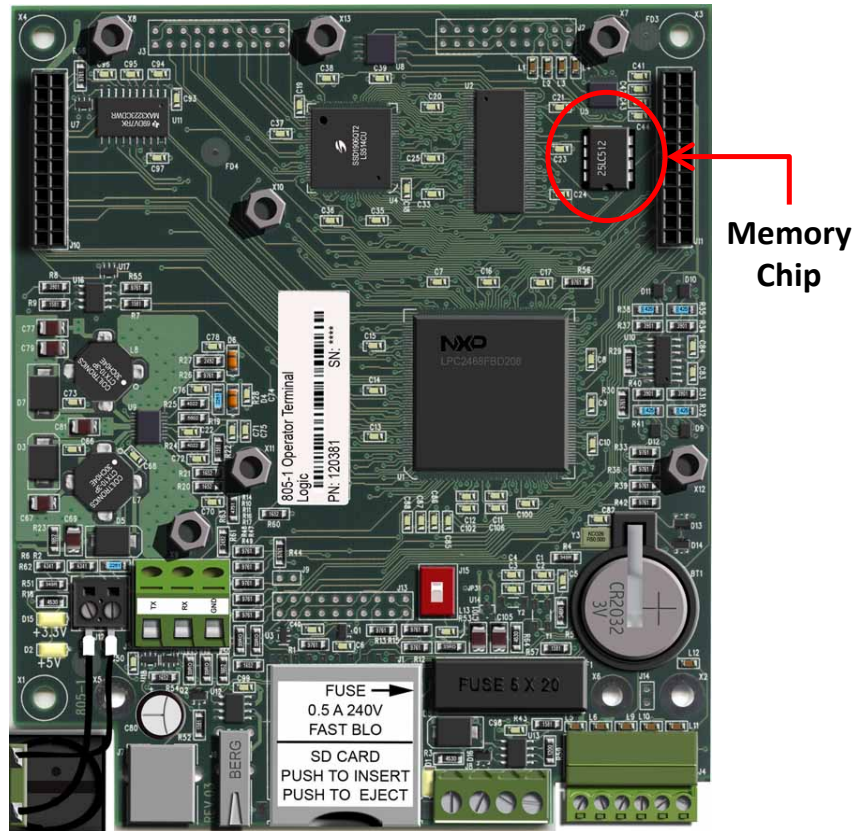

**Figure 27: Memory Chip Location**

In the same manner, remove the chip in the new operator terminal. Now place the chip from the original operator terminal into the socket of the new operator terminal. Pay careful attention to the notch on one side of the chip. It should match the notch in the socket. With the circuit board oriented as shown in Figure 27, the notch in the chip should point down. Also make sure not to bend the leads of the chip under or out as it is being inserted into the socket.

After the memory chip is installed, power up the new operator terminal and verify that the settings are correct.

## 6 INSTALLATION

**NOTE:** Before you begin installation, you should read this entire manual carefully. This will help you to understand system functions and plan the installation to save time and the necessity to rework portions of the installation.

### 6.1 Preliminary Installation Considerations

The 805-8 Machine Monitor comes in two configurations: panel mount for situations where there is available panel space in an existing enclosure, or in a complete enclosure. In either case, try to locate the machine monitor close to the machine control for easy access, keeping in mind that the operator will need to interact with the screen from time to time.

The wiring instructions for installation contained in this manual are necessarily generic since the Machine Monitor may be interfaced with a wide variety of machinery using multiple relay and electronic components. *If the installer has questions related to the proper installation of the system, contact the service personnel at Link Systems.* Always test each component of the system installation to see that proper function is obtained.

**WARNING:** Improper system installation or improper interface from the Machine Monitor to the machine control may result in damage to the machine or other equipment and increase the possibility of injury to operators and others. Use qualified installers.



Installation of this system should be done in accordance with OSHA's lockout/tagout regulations (see CFR 1910.147). You will be mounting Machine Monitor components on or near the machine, and may be exposed to mechanical hazards if machine movement should occur during mounting activities. Depending on the configuration of Machine Monitor purchased and interface requirements to the machine control, you may also be wiring electrical circuits that will use 115VAC or 230VAC voltages. Unless these circuits are de-energized during wiring activities, a serious or even fatal shock may occur. Remove hazardous energy during system installation.

**WARNING:** Failure to comply with CFR 1910.147 regulations and remove hazardous energy during installation of the Machine Monitor may result in serious injury or death! Use only qualified installers trained in lockout procedures for installation.





## 6.2 Mounting the Machine Monitor

The Machine Monitor is usually delivered pre-mounted in an enclosure ready to bolt on to the machine. It is also available without the enclosure, when there is panel space available in an existing enclosure.

In either case, consideration should be given to the viewing angle of the operator. Figure 28 shows the most usable viewing angles for the LCD display used in the Link OIT - about 30 degrees “above” to 45 degrees below is preferable. Going further in either direction by about 20 degrees is possible, if absolutely necessary. Viewing the operator terminal from slightly “below” it generally results in the best display quality.

The panel mount version of the machine monitor requires the panel cutouts and holes shown in Figure 29.

In selecting the mounting location, note not only the panel space required, but also the depth clearance needed for the unit, which is needed to allow for wiring to exit the back. There is also a 1.2” (30mm) clearance needed for wiring and SD Card insertion space at the bottom of the operator terminal

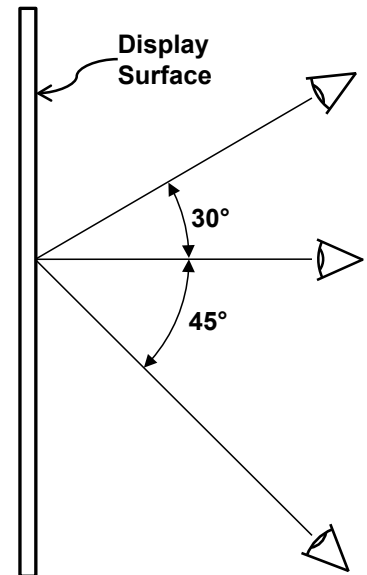

Figure 28: OIT Viewing Angles

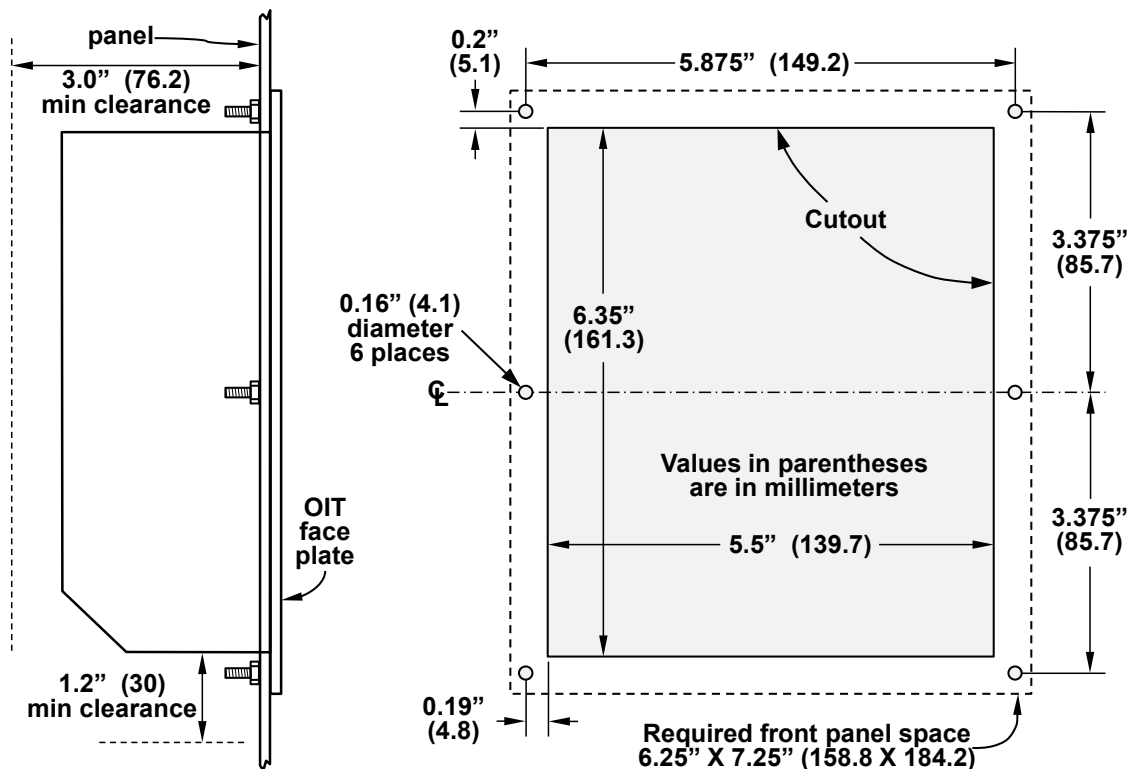
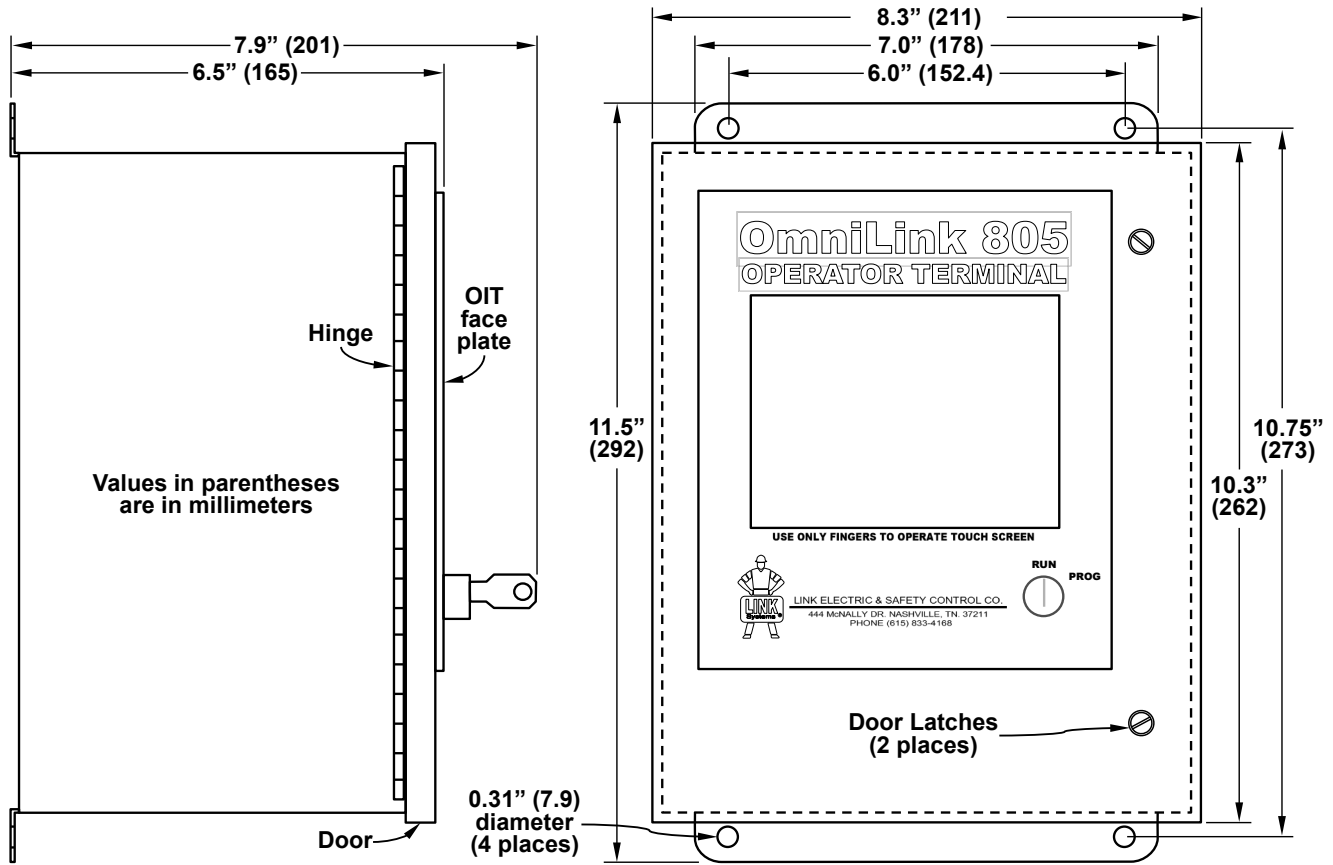

Figure 29: Panel Mounting Dimensions

Figure 30 shows the mounting dimensions of the Machine Monitor that is already in an enclosure. When selecting the mounting location, allow for room to open the door of the enclosure (it swings to the left) and for conduit and/or cable entry to the enclosure. In addition, if the mounting location is subject to heavy vibration, then the enclosure should be mounted using shock mounts.



**Figure 30: Enclosure Mounting Dimensions**

## 6.3 System Wiring

Wiring between the Machine Monitor enclosure (or the enclosure the panel mount version in mounted in) and the machine should be run in conduit. The use of flexible liquid tight conduit with ground is suggested, but hard conduit can also be used.

The conduit runs that may be needed, depending on the configuration of the Machine Monitor and the features used are:

- Conduit for 115VAC or 230VAC connections between the Machine Monitor enclosure and the machine control.
- Conduit for low voltage connections between the Machine Monitor enclosure and the machine control.
- Conduit for sensors on the machine running back to the Machine Monitor.
- Conduit from the Machine Monitor to a stack light.
- Conduit for the Ethernet cable from its drop to the Machine Monitor.

**NOTE:** If you have both 115VAC circuits and low voltage circuits, run them in separate conduits. You can run the Ethernet cable with the low voltage wiring if needed.

The 805-8 Machine Monitor itself operates on +24 VDC and requires up to 400 milliamps (or about 10 watts). The version of the Machine Monitor that comes in an enclosure is supplied with a 30 watt +24 VDC power supply that accepts 90 to 264 VAC, 47 to 63 Hz. The extra capacity of this supply can be used to power sensors (for cycle or part detection, for instance) or indicators (like stack lights) if needed.

**NOTE:** Even though the Machine Monitor that is supplied in an enclosure has a +24 VDC supply, it is not a requirement to use that supply. If the machine the monitor is installed on has 400 milliamps of available capacity on its own +24 VDC supply (about 10 watts) and does not have conveniently available AC power, then the machines supply can be used to power the Machine Monitor in the same way as the panel mounted version.

**WARNING!** *ALWAYS* remove the AC power from the unit before servicing and/or wiring the Monitor. *Lethal voltages are present in the enclosure when the unit is powered!*



**WARNING!** Make sure you completely wire the AC power connections (paying particular attention to making sure the enclosure is grounded) before applying power to the Machine Monitor. *Lethal voltages are present in the enclosure when the unit is powered!*



Figure 31 is a view of the back of the operator terminal showing the location and pinout of the connectors used to interface the Machine Monitor to the machine. Figure 32, next page, shows a view of the version of Machine Monitor that is already in an enclosure.

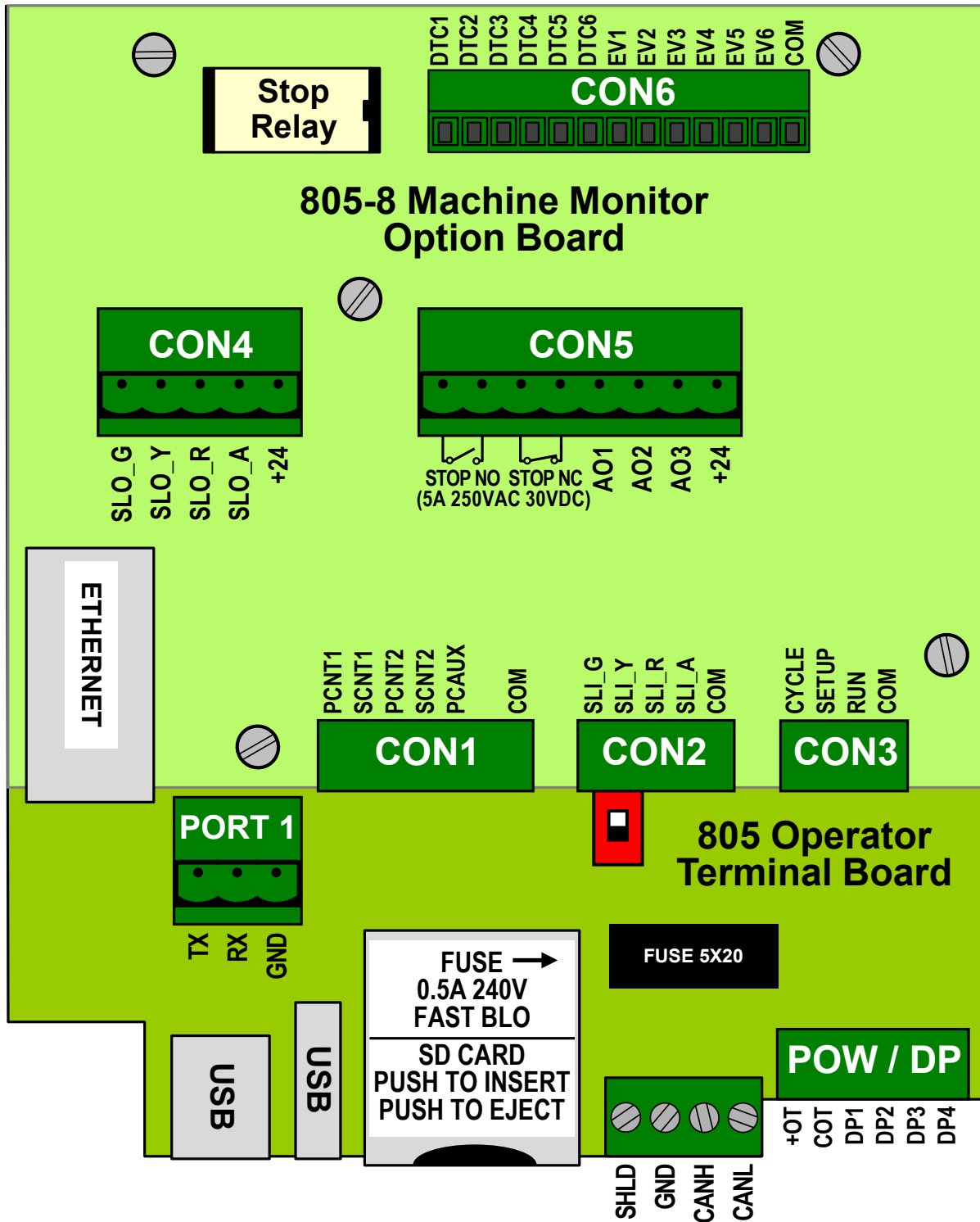

Figure 31: 805-8 Machine Monitor Connectors

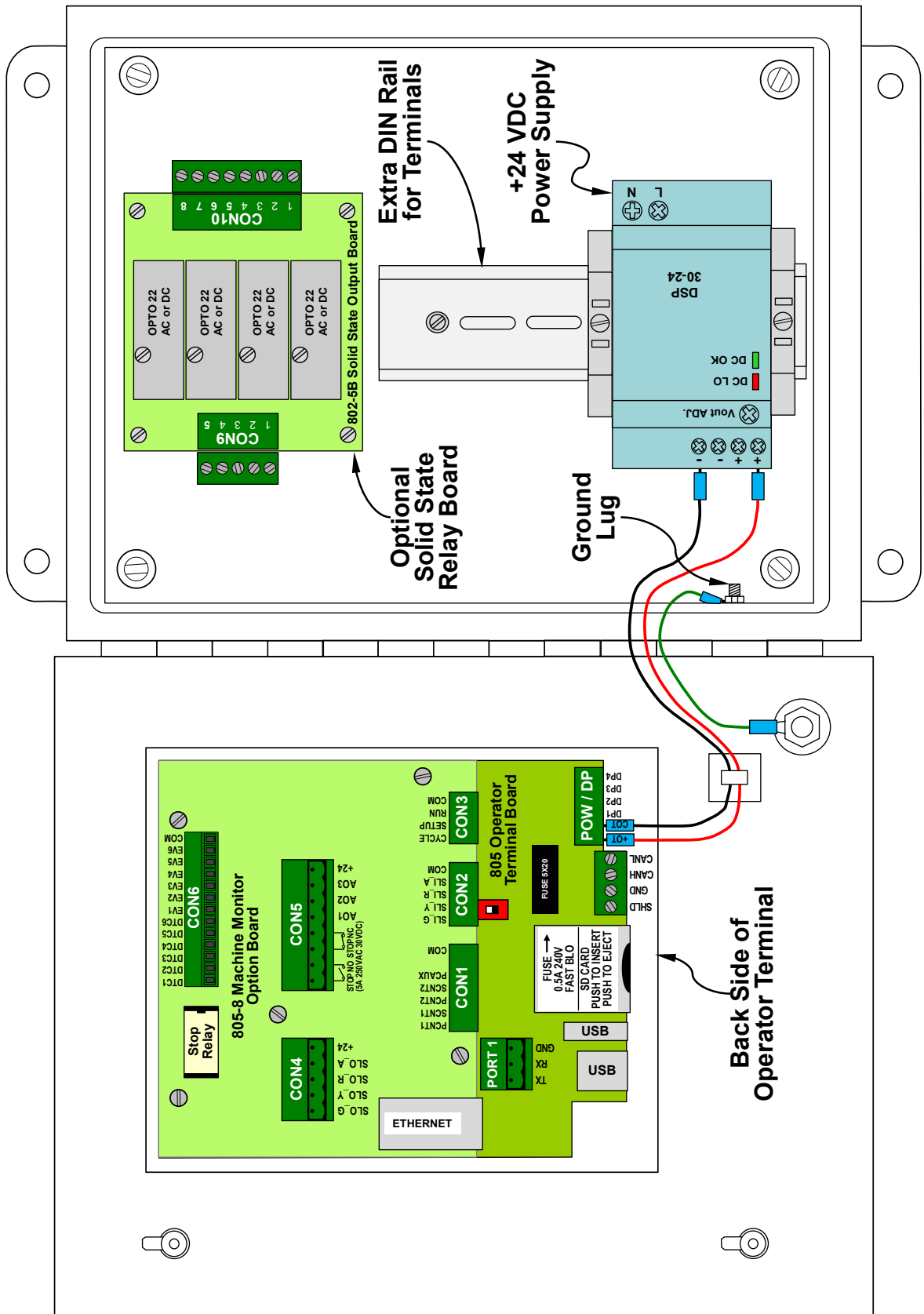



Figure 32: Open Door View of 805-8 Machine Monitor in Enclosure

### 6.3.1 Wiring Power for the System

|   |  |
|---|--|
|  | <p><b>WARNING:</b> National Codes and standard (NEC, VDE, BSI, etc.) and local codes outline provisions for safely installing electrical equipment. Installation must comply with specifications regarding wire types, conductor sizes, branch circuit protection, and disconnect devices. Failure to do so may result in personal injury and/or equipment damage.</p> |
|---|--|

Pull wires with the appropriate color code in conduit between the Machine Monitor enclosure (if used) and the machine control. Remember to run high voltage wiring in one conduit and low voltage wiring, if any, in a separate conduit.

The Machine Monitor itself, whether the panel mounted version or the enclosure version, operates on +24 VDC and requires up to 400 milliamps (or about 10 watts). The power connection is made on the “POW / DP” connector (see Figure 31 on page 42) as shown in the table at right.

| <b>“POW / DP” Connections on 805 Operator Terminal</b> |                                    |
|--|------------------------------------|
| +OT  | +24 VDC Input Power<br>(0.4 Amps ) |
| COT  | Ground - +24VDC Return             |

For the panel mounted version, use at least 18AWG wire to connect the +24 VDC power and ground as shown in the table above.

The version of the Machine Monitor that comes in an enclosure is supplied with a 30 watt +24 VDC power supply that accepts 90 to 264 VAC, 47 to 63 Hz. The +24 VDC output is already wired to the Machine Monitor as shown in Figure 32. Use 16AWG wire to connect the supply as shown in the table at right. ***Note that the power supply itself is double insulated and does not require a separate ground, but that ground (protective earth or PE) must still be connected to the “Ground Lug” in the enclosure (see Figure 32).***

| <b>Power Supply Connections on Enclosure +24 VDC Supply</b> |   |
|---|---|
| L   | 90 – 264 VAC Line<br>37 VA (0.8 Amp)  |
| N   | 90 – 264 VAC Neutral  |
| Ground Lug  | Connect protective earth to the ground lug on the enclosure (see Figure 32) |

## 6.3.2 Wiring Inputs

The Machine Monitor has several input connectors to allow the machine to indicate certain conditions or events, such as making a cycle. Each input connector has a “COM” terminal, which is the common for that connector (see Figure 31, CON1, CON2, CON3, and CON6).

The inputs on the connectors mentioned above are optically coupled, isolated inputs and so can be driven from different supplies than are powering the Machine Monitor. Note that you can use the same supply that is powering the Machine Monitor, but if you are coming off a PLC output from the machine it may be more convenient not to.

The COM terminal on each input connector must be tied to either ground or +24VDC from the device that is driving it. If the “COM” terminal for a connector is tied to ground, then +24 VDC on an input on that connector will turn that input “On”. Likewise if the “COM” terminal is tied to +24 VDC, then grounding the input will turn it “On”. Figure 33 shows an example of the CON3 connector wired up in each of these configurations.

While Figure 33 is showing relay contact driving the inputs, anything that can switch between ground and +24 VDC will work. For instance, when the “COM” terminal is tied to +24 VDC, then an NPN proc sensor could drive the input. If the “COM” terminal is tied to ground, then a PNP proc sensor could drive the input.

**NOTE:** Remember that each of the CON1, CON2, CON3, and CON6 connectors has its own independent “COM” terminal that must be tied to either ground or +24 VDC but they do not have to be the same across all connectors.

Use the input diagnostic screen (see Section 3.7.1 on page 21) to verify that the input is turning “On” and “Off” as expected.

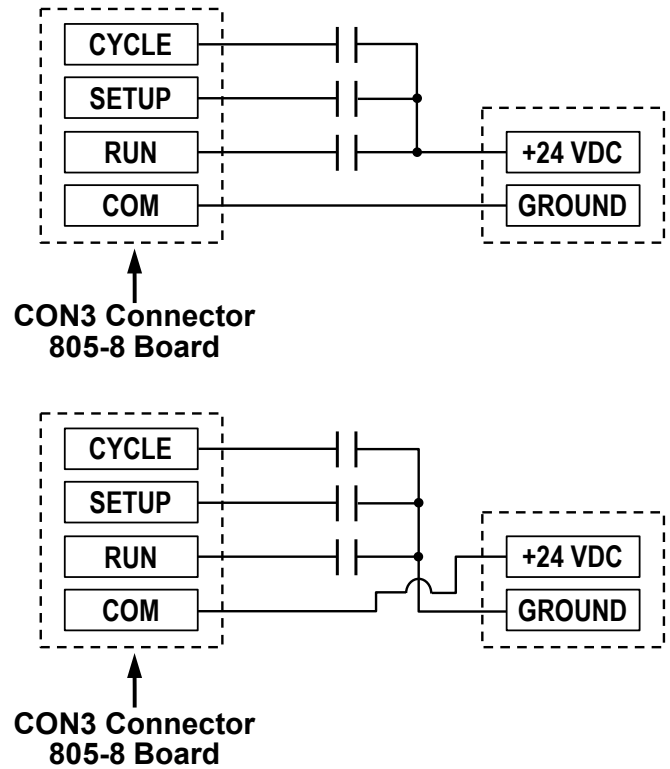

Figure 33: Example Input Connections

The inputs (see Figure 31 on page 42 for locations) and their functions are:

**CON1  
PCNT1** This input increments Part Count 1 and Bin Count 1 when it switched from “Off” to “On”. This is used when counters are being driven by sensors actually detecting parts as they come off the machine. This is especially useful when the number of cycles do not match up with the number of parts (2 parts per cycle, 10 cycles per part, etc.). It’s also useful when the machine or process does its own part validation and can reject a part, which can be counted as scrap by the SCNT1 input. If not used, the Machine Monitor can drive its counters from the CYCLE input.

**CON1  
SCNT1** This input increments Scrap Count 1 when it switched from “Off” to “On”. This is especially useful when the machine or process does its own part validation and can reject a part. If not used, the operator can manually indicate when scrap is made.

**CON1  
PCNT2** This input increments Part Count 1 and Bin Count 1 when it switched from “Off” to “On”. See the explanation under PCNT1 for more information.

**CON1  
SCNT2** This input increments Scrap Count 1 when it switched from “Off” to “On”. See the explanation under SCNT1 for more information.

**CON1  
PCAUX** Not used at this time.

**CON2  
SLI\_G** When “On”, indicates the machine wants the green stack light to be lit. This can be used to optionally integrate the Machine Monitor into an existing stack light that is already being used by the machine.

**CON2  
SLI\_Y** When “On”, indicates the machine wants the yellow stack light to be lit. This can be used to optionally integrate the Machine Monitor into an existing stack light that is already being used by the machine.

**CON2  
SLI\_R** When “On”, indicates the machine wants the red stack light to be lit. This can be used to optionally integrate the Machine Monitor into an existing stack light that is already being used by the machine.

**CON2  
SLI\_A** When “On”, indicates the machine wants the auxiliary (could be any color – basically a fourth light on the stack) stack light to be lit. This can be used to optionally integrate the Machine Monitor into an existing stack light that is already being used by the machine.



|                                  |  |
|----------------------------------|--|
| <b>CON3<br/>CYCLE</b>            | When the CYCLE input switched from “Off” to “On”, it indicates that the machine has just made a cycle. This input is the only input that is actually required to be connected. If the part and scrap count inputs are not used, then this input can also be used to drive the counters.  |
| <b>CON3<br/>SETUP</b>            | When “On”, this input indicates the machine is in “Setup” mode, rather than “Production” mode. If this input is not used then the system can be configured to allow the operator to manually indicate the mode.  |
| <b>CON3<br/>RUN</b>              | When “On”, this input indicates the machine is “Running”. If this input is not used then the CYCLE input in combination with a timeout can be used to indicate the machine is running (see Section 4.2.1).   |
| <b>CON6<br/>DTC1 to<br/>DTC6</b> | When “On”, these inputs indicate that a down time condition is in effect. This will cause, if configured for it, a particular down time code to become active. If multiple inputs are on at the same time, then priority will be given to the lower input number. For example, if DTC1 and DTC3 are both on, then DTC1 will “win”. |
| <b>CON6<br/>EV1 to EV6</b>       | When these inputs switch from “Off” to “On”, then, when configured for it, an event code associated with the input will be logged to the network.  |

### 6.3.3 Wiring Outputs

The primary output on the Machine Monitor is a Stop relay that can be used to stop the machine when, for instance, a counter limit is reached or if you want to force the operator to enter a down time code after the machine has gone idle. CON5 (see Figure 31 on page 42) has the following terminals:

|                            |  |
|----------------------------|--|
| <b>CON5<br/>STOP NO</b>    | These two terminals are the normally open contact of the stop relay and are the ones that would typically be wired into the machine stop circuit. During normal operation when no Stop is being asserted, these contacts are closed. If a Stop from the Machine Monitor is active, or if the Machine Monitor loses power, this contact will open up. While not required, |
| <b>CON5<br/>STOP NC</b>    | These two terminals are the normally closed contact of the stop relay and will be the opposite of the normally open contact described above. This contact is provided for the rare case where some auxiliary indication is needed, but is typically not used.  |
| <b>CON5<br/>AO1 to A03</b> | Reserved for future use.   |

**CON5**  
**+24**

Reserved for future use.